



Slide Rail

THK General Catalog

A Product Descriptions

Features and Types	A13-2
Features of the Slide Rail	A13-2
• Structure and Features	A13-2
Types of the Slide Rail	A13-3
• Types and Features	A13-3
Classification Table for Slide Rails.....	A13-12
Dimensional Drawing, Dimensional Table	
Model FBL 27S	A13-14
Model FBL 27S-P14	A13-15
Model FBL 35S	A13-16
Model FBL 35S-P13	A13-17
Model FBL 35S-P14	A13-18
Model FBL 35M	A13-19
Model FBL 35J	A13-20
Model FBL 35B	A13-21
Model FBL 35T	A13-22
Model FBL 27D	A13-23
Model FBL 35E	A13-24
Model FBL 35E-P14	A13-25
Model FBL 35G-P13	A13-26
Model FBL 35G-P14	A13-27
Model FBL 35D	A13-28
Model FBL 35W	A13-29
Model FBL 51H	A13-30
Model FBL 51H-P13	A13-31
Model FBL 51H-P14	A13-32
Model FBL 35K	A13-33
Model FBL 56H	A13-34
Model FBL 56H-P13	A13-35
Model FBL 56H-P14	A13-36
Model FBL 35F	A13-37
Model FBL 56F	A13-38
Model FBL 48DR	A13-39
Model E36RS	A13-40
Model E15	A13-41
Model E20	A13-42
Model D20	A13-43
Point of Design	A13-44
Model No.	A13-46
• Model Number Coding	A13-46
Precautions on Use	A13-48

B Support Book (Separate)

Features and Types	B13-2
Features of the Slide Rail	B13-2
• Structure and Features	B13-2
Types of the Slide Rail	B13-3
• Types and Features	B13-3
Classification Table for Slide Rails.....	B13-12
Mounting Procedure	B13-14
Mounting the Slide Rail.....	B13-14
Model No.	B13-17
• Model Number Coding	B13-17
Precautions on Use	B13-19

Features of the Slide Rail

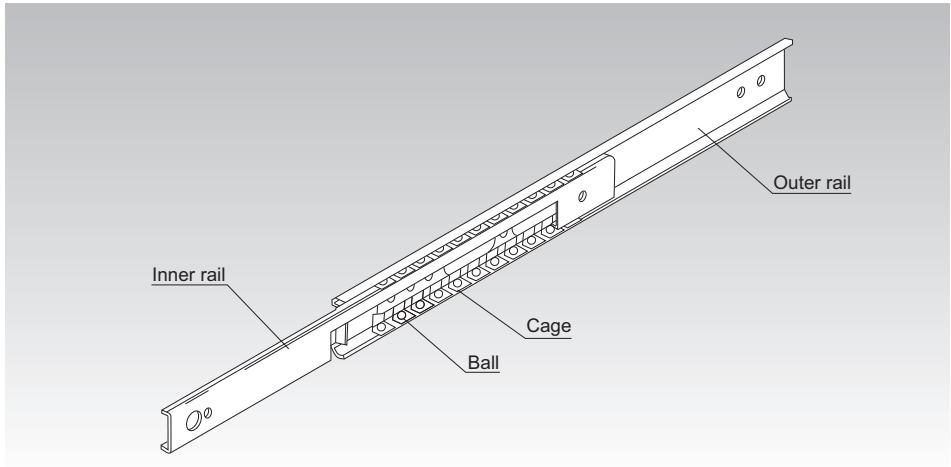

Fig.1 Structure of Slide Rail Model FBL

Structure and Features

Slide Rail model FBL is a thin, compact, lightweight and ultra-low price slide unit for finite motion. It has two rows of balls placed between an inner rail (made of a steel sheet roll-formed with precision) and an outer rail. The balls are evenly spaced by a cage press-molded with precision, thus eliminating friction between balls and achieving a smooth slide mechanism.

Since model FBL achieves smooth straight motion with easy installation, it can be used in a wide range of applications such as photocopiers, measuring instruments, telecommunication equipment, medical equipment, automatic vending machines and various types of office equipment.

[Unit Type That Allows Easy Installation]

Since the clearance and the motion of the slide unit are optimally adjusted, simply mounting the unit onto the base or the table using screws will achieve a slide mechanism with virtually no running noise.

[Thin and Compact]

Since the sectional shape is thin designed, this slide pack only requires a small side space for installation. In addition, a desired number of slide pack units can be installed in parallel according to the load conditions.

[Maintenance-free Operation]

Since the Slide Rail model FBL is treated with zinc plating, and models E and D are treated with white alumite treatment, they are highly corrosion resistant. In addition, the slide unit contains lithium soap-based grease, which is highly stable against oxidation.

Types of the Slide Rail

Types and Features

[Single Slides for Light Load]

Model FBL 27S

Specification Table⇒ **A**13-14

The most compact slide rail from THK.

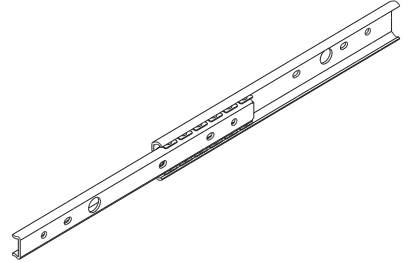

Model FBL 27S

Model FBL 27S-P14

Specification Table⇒ **A**13-15

An inner rail pulling type of model FBL 27S. Releasing the automatic free disconnection spring attached on the inner rail allows the slide rail to be pulled out. When stored, the spring is automatically released unidirectionally under a certain pressure.

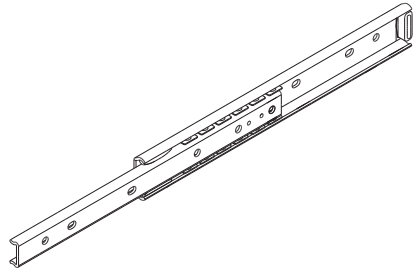

Model FBL 27S-P14

Model FBL 35S

Specification Table⇒ **A**13-16

A single slide type of Slide Rail with the most fundamental shape.

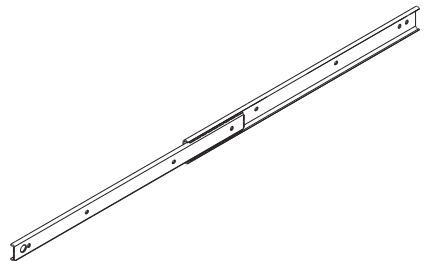

Model FBL 35S

Model FBL 35S-P13

Specification Table⇒[A13-17](#)

An inner rail pulling type of model FBL 35S. Releasing the disconnection spring attached on the inner rail allows the slide rail to be pulled out. When folded, the locked state with the disconnect spring is manually released.

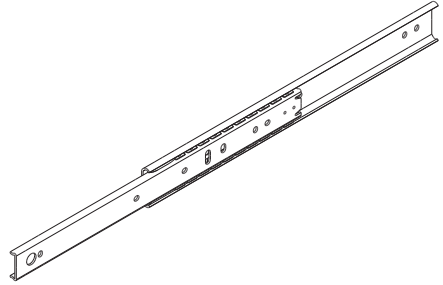

Model FBL 35S-P13

Model FBL 35S-P14

Specification Table⇒[A13-18](#)

An inner rail pulling type of model FBL 35S. Releasing the automatic free disconnection spring attached on the inner rail allows the slide rail to be pulled out. When stored, the spring is automatically released unidirectionally under a certain pressure.

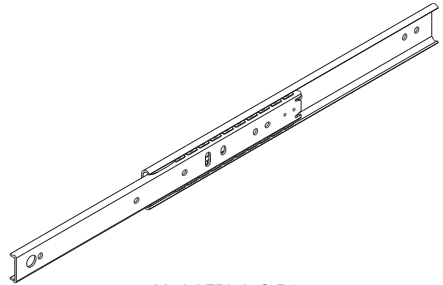

Model FBL 35S-P14

Model FBL 35M

An inner rail pulling type of model FBL 35S. It stops by frictional resistance when the slide rail is fully opened, and is pulled out when being pulled further with force.
(brake-stop type)

Specification Table⇒ **A** 13-19

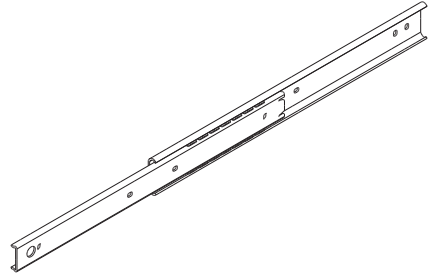

Model FBL 35M

Model FBL 35J

Based on model FBL 35M, this model has a lead ball that serves as a guide when the inner rail is inserted.

Specification Table⇒ **A** 13-20

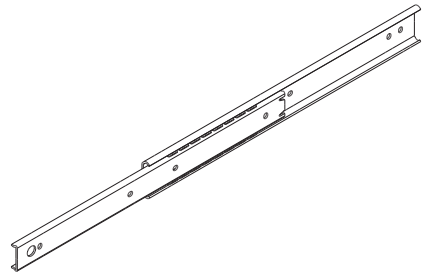

Model FBL 35J

Model FBL 35B

A brake-stop type of model FBL 35M. It can be mounted on the bottom face of a moving object when used.

Specification Table⇒ **A** 13-21

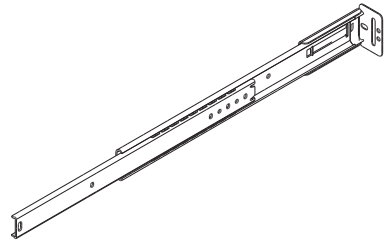

Model FBL 35B

[Single Slides for Medium Load]

Model FBL 35T

Specification Table⇒ **A13-22**

A single slide combining two units of model FBL 35S. It is optimal for locations under a large working load.

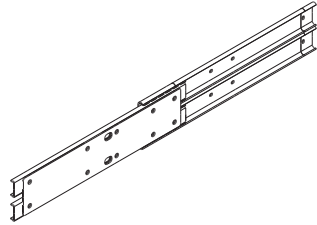

Model FBL 35T

[Double Slides for Light Load]

Model FBL 27D

Specification Table⇒ **A13-23**

A double-slide type that combines two units of model FBL 27S back-to-back. It is widely used in various types of OA equipment.

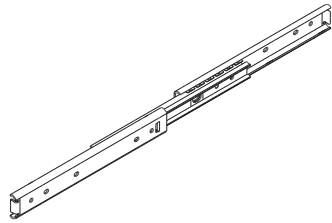

Model FBL 27D

Model FBL 35E

Specification Table⇒ **A13-24**

This is a 2-level slide-unit type suitable for restricted spaces, featuring a stroke length that can exceed the total rail length.

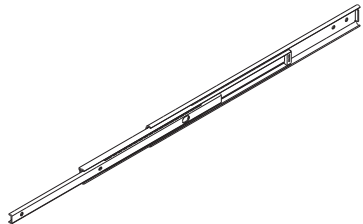

Model FBL 35E

Model FBL 35E-P14

Specification Table⇒ **A13-25**

A three-rail, double-slide type that allows a long stroke in a small space. Releasing the automatic free disconnection spring attached on the inner rail allows the inner rail to be pulled out. When closed, the locked state is automatically released under pressure in the closing direction.

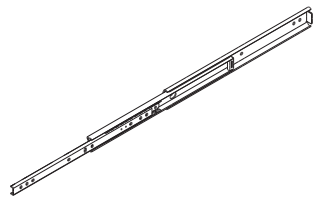

Model FBL 35E-P14

[Double Slides for Medium Load]

Model FBL 35G-P13

A double-slide type that combines two units of model FBL 35S front-to-front. Releasing the automatic free disconnection spring attached on the inner rail allows the inner rail to be pulled out. When folded, the locked state with the disconnect spring is manually released. It is also equipped with a pull-lock mechanism that functions when the slide rail is fully opened.

Specification Table⇒ **A** 13-26

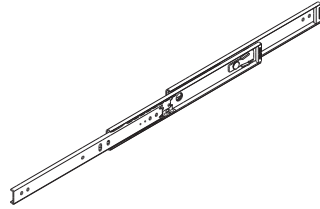

Model FBL 35G-P13

Model FBL 35G-P14

A double-slide type that combines two units of model FBL 35S front-to-front. Releasing the automatic free disconnection spring attached on the inner rail allows the inner rail to be pulled out. When folded, the lock state with the disconnect spring can automatically be released under a certain pressure in the folding direction. It is also equipped with a pull-lock mechanism that functions when the slide rail is fully opened.

Specification Table⇒ **A** 13-27

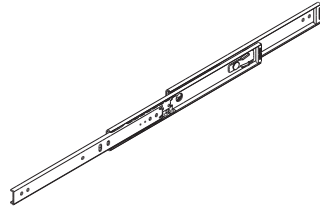

Model FBL 35G-P14

Model FBL 35D

A double-slide type that combines two units of model FBL 35S back-to-back. It is extensively used regardless of the industry.

Specification Table⇒ **A** 13-28

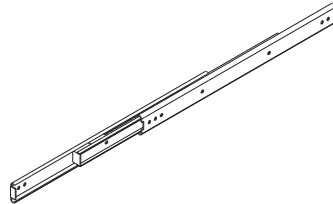

Model FBL 35D

Model FBL 35W

A double-slide type based on model FBL 35S that achieves a thickness of one single-slide unit.

Specification Table⇒ **A** 13-29

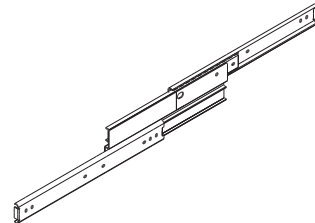

Model FBL 35W

Model FBL 51H

Specification Table⇒ **A13-30**

A three-rail, double-slide type that allows a long stroke. With the smallest thickness, this model can be used in a space-saving location even under a large load.

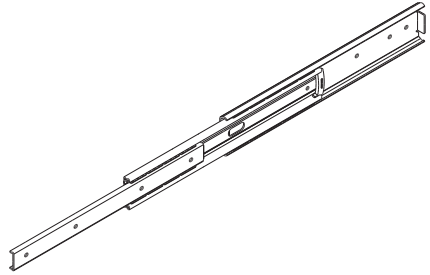

Model FBL 51H

Model FBL 51H-P13

Specification Table⇒ **A13-31**

A three-rail, double-slide type that allows a long stroke. With the smallest thickness, this model can be used in a space-saving location even under a large load. Releasing the automatic free disconnection spring attached on the inner rail allows the inner rail to be pulled out. When folded, the locked state with the disconnect spring is manually released. It is also equipped with a lock mechanism that functions when the slide rail is fully opened.

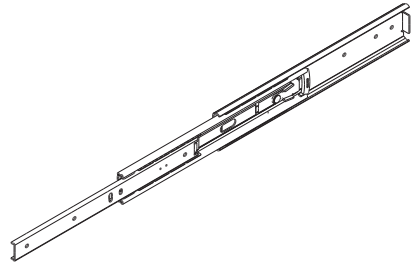

Model FBL 51H-P13

Model FBL 51H-P14

Specification Table⇒ **A13-32**

A three-rail, double-slide type that allows a long stroke. With the smallest thickness, this model can be used in a space-saving location even under a large load. Releasing the automatic free disconnection spring attached on the inner rail allows the inner rail to be pulled out. When closed, the locked state is automatically released under pressure in the closing direction.

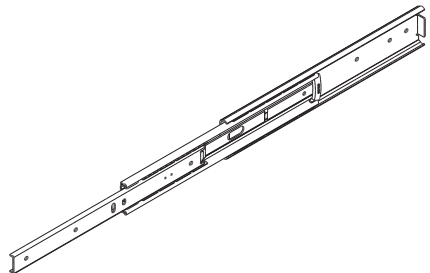

Model FBL 51H-P14

[Double Slides for Heavy Load]

Model FBL 35K

A double-slide type combining 4 units of model FBL 35S. It achieves the largest permissible load among all types and is optimal for opening/closing heavy objects.

Specification Table⇒ **A 13-33**

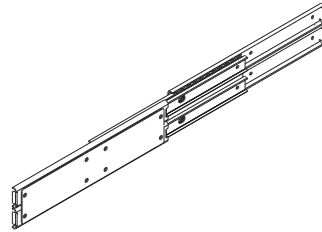

Model FBL 35K

Model FBL 56H

A double-slide type with the largest permissible load among the three rails. It is used extensively in various types of OA furniture.

Specification Table⇒ **A 13-34**

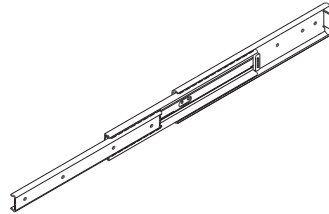

Model FBL 56H

Model FBL 56H-P13

A double-slide type with the largest permissible load among the three rails. Releasing the automatic free disconnection spring attached on the inner rail allows the inner rail to be pulled out. When folded, the locked state with the disconnect spring is manually released. It is also equipped with a lock mechanism that functions when the slide rail is fully opened.

Specification Table⇒ **A 13-35**

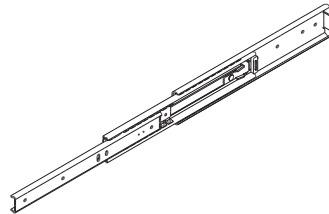

Model FBL 56H-P13

Model FBL 56H-P14

A double-slide type with the largest permissible load among the three rails. Releasing the automatic free disconnection spring attached on the inner rail allows the inner rail to be pulled out. When closed, the locked state is automatically released under pressure in the closing direction.

Specification Table⇒ **A 13-36**

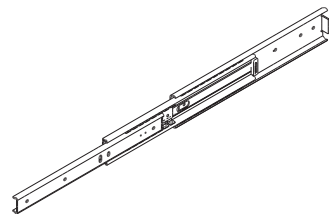

Model FBL 56H-P14

[Linear Type Slides]

Light Load Type Model FBL 35F

Specification Table⇒ **A13-37**

Using a flange type that can easily be mounted, this slide-type model is capable of performing straight, finite motion.

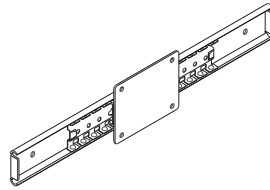

Light Load Type Model FBL 35F

Medium Load Type Model FBL 56F

Specification Table⇒ **A13-38**

Using a flange type that can easily be mounted, this slide-type model is capable of performing straight, finite motion. It is optimal for locations under a large working load.

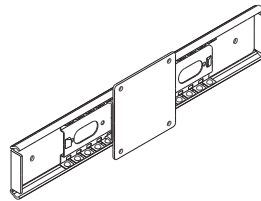

Medium Load Type Model FBL 56F

Heavy Load Type Model FBL 48DR

Specification Table⇒ **A13-39**

A heavy-load, low-friction slide rail developed for sliding heavy doors.



Heavy Load Type Model FBL 48DR

[Wheel-type Linear Slide]

Model E36RS

Specification Table⇒ **A13-40**

A linear slide that combines a lightweight outer rail made of precision-extruded aluminum alloy with a highly wear-resistant resin bearing.

Since no grease adheres to the rail surface, it can be used for a drawer without soiling the stored articles.

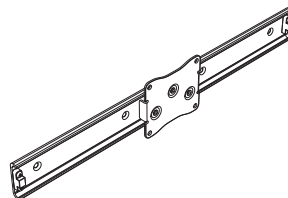

Model E36RS

[Aluminum Alloy Slide Rail]

Light Load Type Model E15

Specification Table⇒ **A13-41**

The lightest and most compact single slide in the aluminum alloy series. It is especially suitable for locations with magnetism, locations requiring antirust measures and locations where much importance is given to appearance.

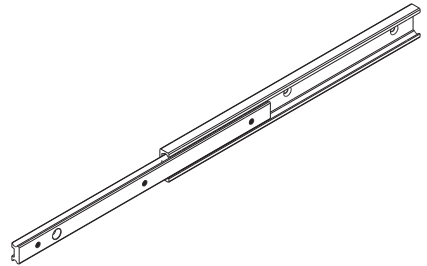

Light Load Type Model E15

Light Load Type Model E20

Specification Table⇒ **A13-42**

A single-slide with the most fundamental shape in the aluminum alloy series. It is especially suitable for locations with magnetism, locations requiring antirust measures and locations where much importance is given to appearance.

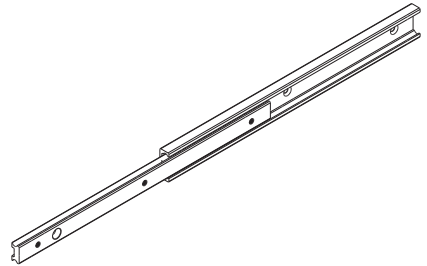

Light Load Type Model E20

Light Load Type Model D20

Specification Table⇒ **A13-43**

The lightest and most compact double slides in the aluminum alloy series. It is especially suitable for locations with magnetism, locations requiring antirust measures and locations where much importance is given to appearance.

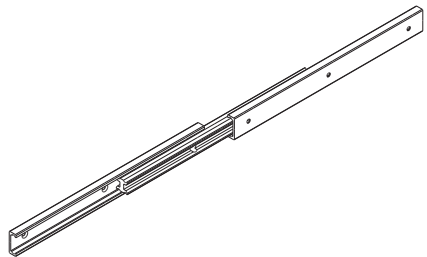





Light Load Type Model D20

Classification Table for Slide Rails

Slide Rail

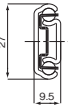
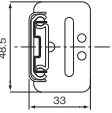
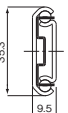
Single Slide Double Slide

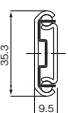
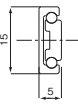
For Light Load

<p>Model FBL27S</p> <p>Model FBL27S-P14</p> 	<p>Model FBL35B</p> 
<p>Model FBL35S</p> <p>Model FBL35S-P13</p> <p>Model FBL35S-P14</p> 	<p>Model FBL35J</p> 
<p>Model FBL35M</p> 	<p>Model E15 (Made of Aluminum)</p> 
	<p>Model E20 (Made of Aluminum)</p> 

For Medium Load

Model FBL35T

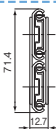

For Light Load

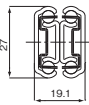
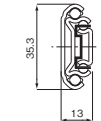
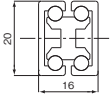
<p>Model FBL27D</p> 	<p>Model FBL35E</p> <p>Model FBL35E-P14</p> 
<p>Model D20 (Made of Aluminum)</p> 	

For Heavy Load

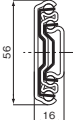
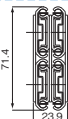
<p>Model FBL56H</p> <p>Model FBL56H-P13</p> <p>Model FBL56H-P14</p> 
<p>Model FBL35K</p> 

Linear Type Slide

For Medium Load

Model FBL35G-P13

Model FBL51H

Model FBL35G-P14

Model FBL51H-P13

Model FBL51H-P14

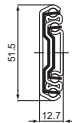
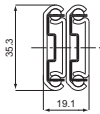

Model FBL35D

Model FBL35W

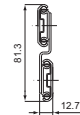
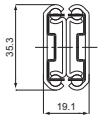

For Light Load

Model FBL35F

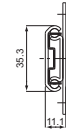

For Medium Load

Model FBL56F

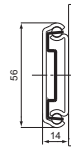

For Heavy Load

Model FBL48DR

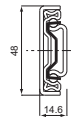

Wheel Type

Model E36RS (Aluminum Outer Rail)



Slide Rail

Model FBL 27S

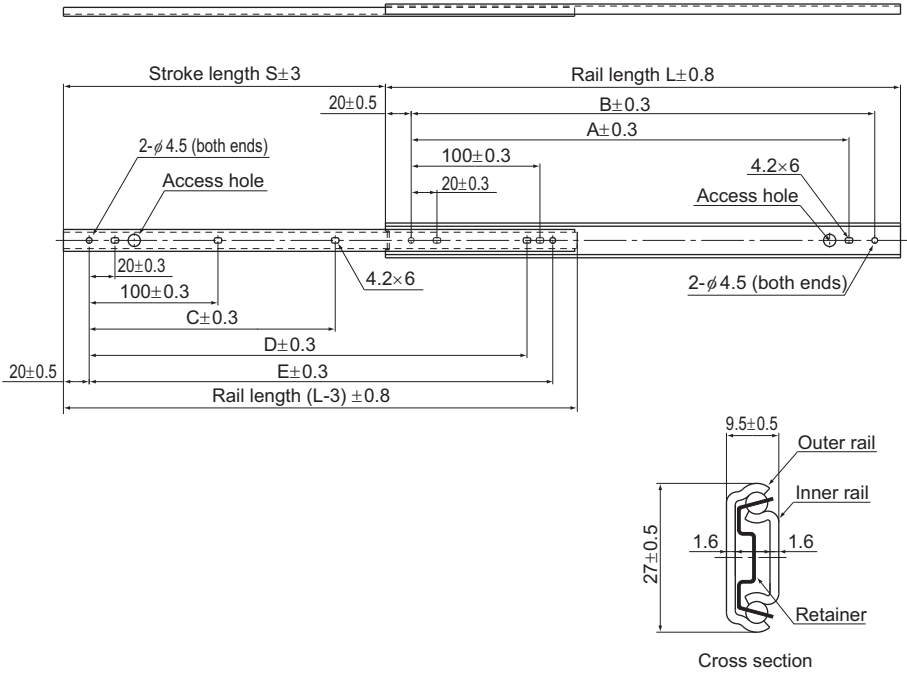

Unit: mm

Rail length L (±0.8)	Stroke S (±3)	Mounting hole dimensions					Mounting hole		Permissible load N/pair	Mass kg/pair
		A	B	C	D	E	Inner rail	Outer rail		
200	135	140.0	160.0	—	140.0	160.0	5	5	260	0.32
250	185	190.0	210.0	150.0	190.0	210.0	6	5	240	0.40
300	222	240.0	260.0	190.0	240.0	260.0	6	5	240	0.48
350	260	290.0	310.0	225.0	290.0	310.0	6	5	230	0.56
400	297	340.0	360.0	265.0	340.0	360.0	6	5	210	0.64
450	334	390.0	410.0	300.0	390.0	410.0	6	5	200	0.72
500	371	440.0	460.0	337.0	440.0	460.0	6	5	180	0.80

Note) The Permissible Load and Mass each indicate when used as a pair of 2 units.

Model number coding

FBL27S +300L

Model number Overall rail length (mm)

Model FBL 27S-P14

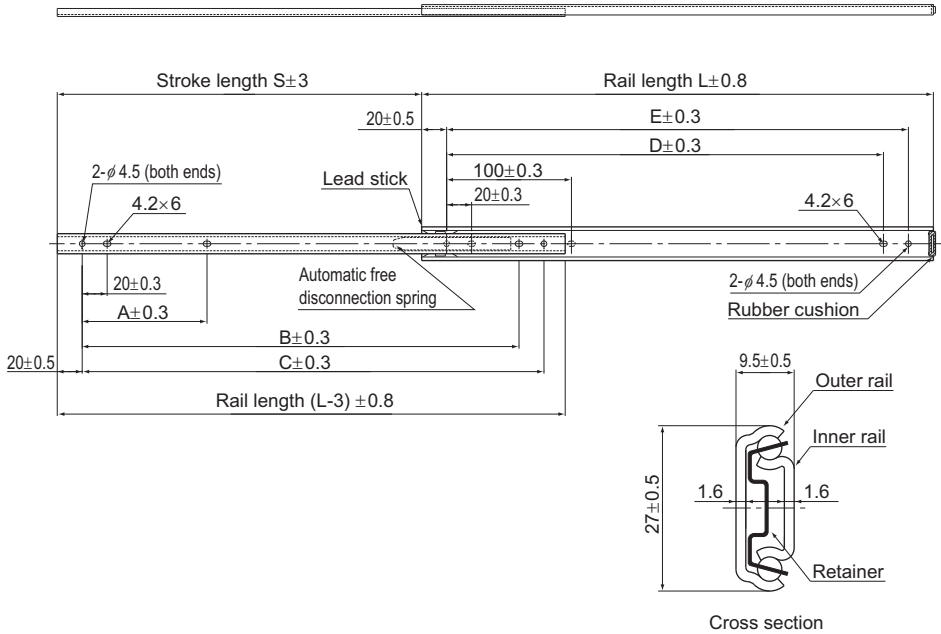

Unit: mm

Rail length L (±0.8)	Stroke S (±3)	Mounting hole dimensions					Mounting hole		Permissible load N/pair	Mass kg/pair
		A	B	C	D	E	Inner rail	Outer rail		
200	116	65.0	—	170.0	140.0	160.0	4	5	260	0.32
250	152	100.0	—	210.0	190.0	210.0	4	5	240	0.40
300	202	100.0	—	260.0	240.0	260.0	4	5	240	0.48
350	251	100.0	—	310.0	290.0	310.0	4	5	230	0.56
400	297	100.0	—	360.0	340.0	360.0	4	5	210	0.64
450	332	100.0	390.0	410.0	390.0	410.0	5	5	210	0.72
500	371	100.0	440.0	460.0	440.0	460.0	5	5	200	0.80
550	407	100.0	490.0	510.0	490.0	510.0	5	5	180	0.80

Note) The Permissible Load and Mass each indicate when used as a pair of 2 units.

Model number coding

FBL27S-P14 +500L

Model number

Overall rail length (mm)

Model FBL 35S

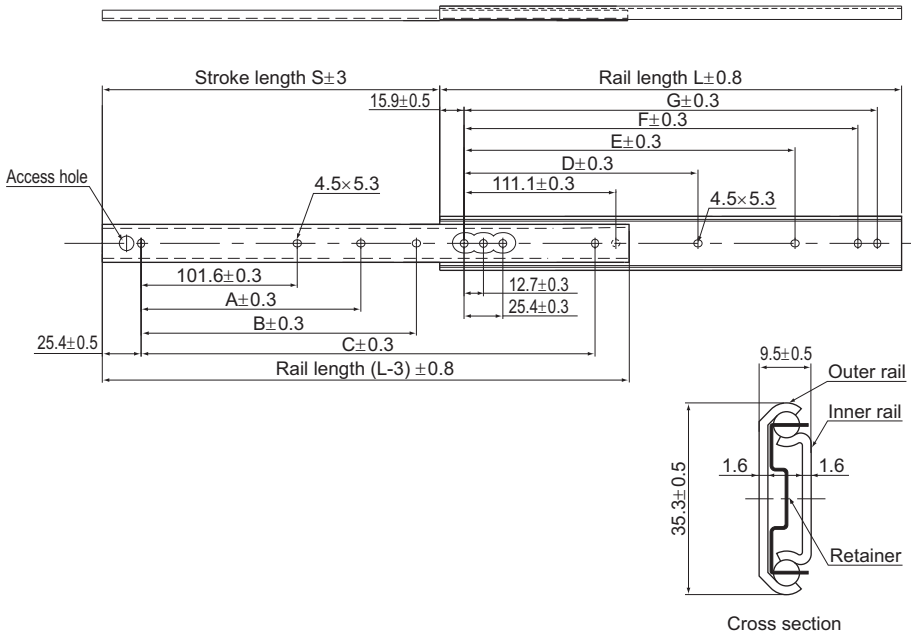

Unit: mm

Rail length L (±0.8)	Stroke S (±3)	Mounting hole dimensions							Mounting hole		Permissible load N/pair	Mass kg/pair
		A	B	C	D	E	F	G	Inner rail	Outer rail		
305	229	—	152.4	254.0	—	149.2	260.3	273.0	4	7	490	0.6
356	279	—	203.2	304.8	—	200.0	311.1	323.8	4	7	400	0.7
406	305	—	254.0	355.6	—	250.8	361.9	374.6	4	7	390	0.8
457	330	203.2	304.8	406.4	212.7	301.6	412.7	425.4	5	8	380	0.9
508	381	228.6	355.6	457.2	238.1	352.4	463.5	476.2	5	8	330	1.0
559	406	254.0	406.4	508.0	263.5	403.2	514.3	527.0	5	8	320	1.1
610	432	279.4	457.2	558.8	288.9	454.0	565.1	577.8	5	8	310	1.2
660	483	304.8	508.0	609.6	314.3	504.8	615.9	628.6	5	8	280	1.3
711	508	330.2	558.8	660.4	339.7	555.6	666.7	679.4	5	8	270	1.4

Note) The Permissible Load and Mass each indicate when used as a pair of 2 units.

Model number coding

FBL35S +457L

Model number Overall rail length (mm)

Model FBL 35S-P13

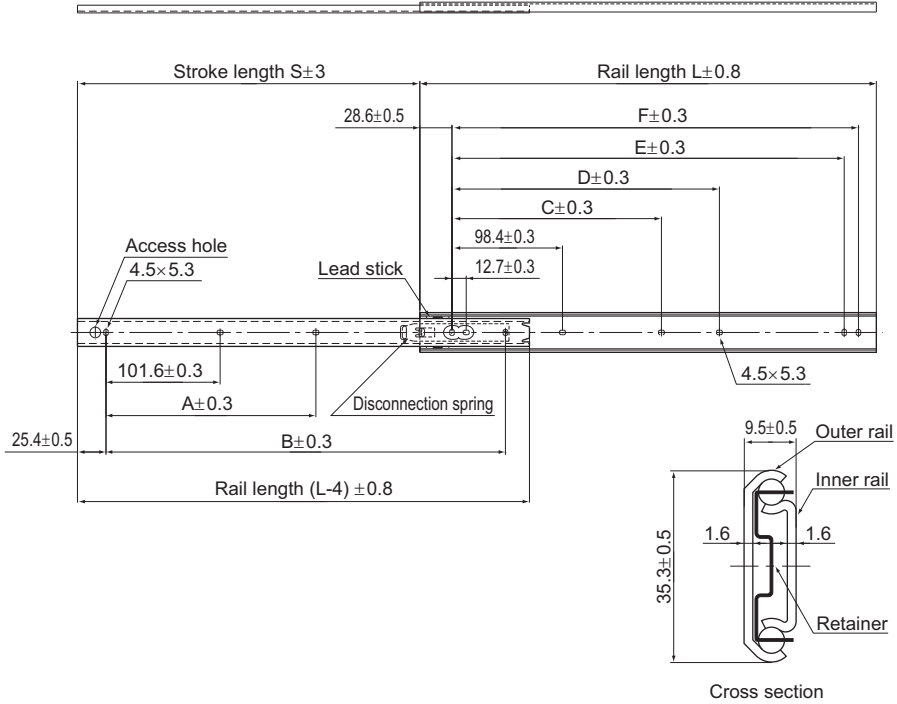

Unit: mm

Rail length L (±0.8)	Stroke S (±3)	Mounting hole dimensions						Mounting hole		Permissible load N/pair	Mass kg/pair
		A	B	C	D	E	F	Inner rail	Outer rail		
305	224	152.4	—	136.5	—	247.6	260.3	3	6	490	0.6
356	275	203.2	—	187.3	—	298.4	311.1	3	6	400	0.72
406	315	254.0	—	238.1	—	349.2	361.9	3	6	390	0.84
457	330	203.2	406.4	200.0	288.9	400.0	412.7	4	7	380	0.96
508	381	228.6	457.2	225.4	339.7	450.8	463.5	4	7	330	1.04
559	406	254.0	508.0	250.8	390.5	501.6	514.3	4	7	320	1.16
610	432	279.4	558.8	276.2	441.3	552.4	565.1	4	7	310	1.24
660	483	304.8	609.6	301.6	492.1	603.2	615.9	4	7	280	1.36
711	493	330.2	660.4	327.0	542.9	654.0	666.7	4	7	270	1.48

Note) The Permissible Load and Mass each indicate when used as a pair of 2 units.

Model number coding

FBL35S-P13 +559L

Model number

Overall rail length (mm)

Model FBL 35S-P14

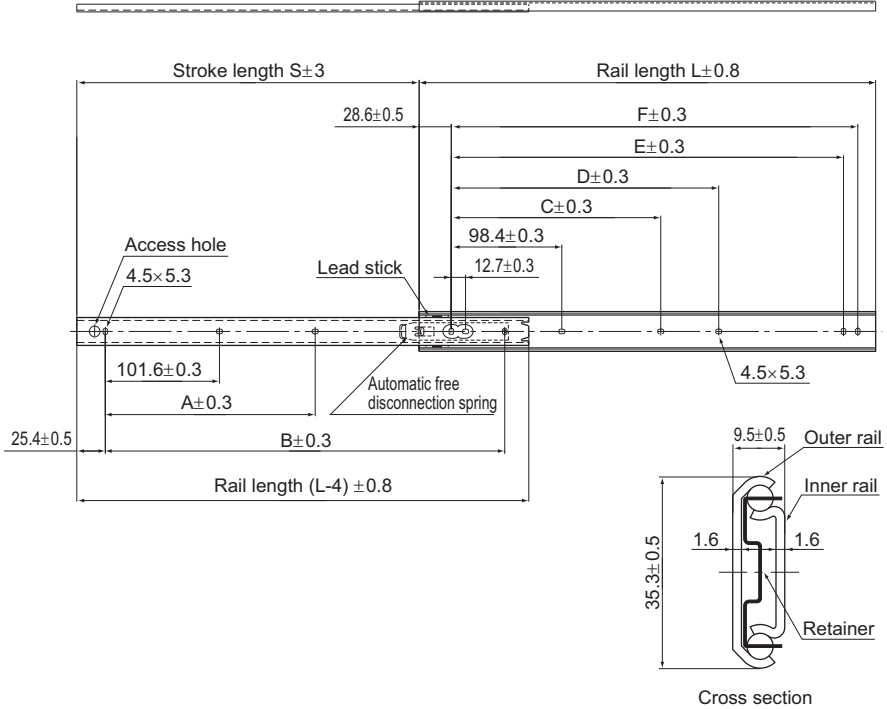

Unit: mm

Rail length L (±0.8)	Stroke S (±3)	Mounting hole dimensions						Mounting hole		Permissible load N/pair	Mass kg/pair
		A	B	C	D	E	F	Inner rail	Outer rail		
305	224	152.4	—	136.5	—	247.6	260.3	3	6	490	0.6
356	275	203.2	—	187.3	—	298.4	311.1	3	6	400	0.72
406	315	254.0	—	238.1	—	349.2	361.9	3	6	390	0.84
457	330	203.2	406.4	200.0	288.9	400.0	412.7	4	7	380	0.96
508	381	228.6	457.2	225.4	339.7	450.8	463.5	4	7	330	1.04
559	406	254.0	508.0	250.8	390.5	501.6	514.3	4	7	320	1.16
610	432	279.4	558.8	276.2	441.3	552.4	565.1	4	7	310	1.24
660	483	304.8	609.6	301.6	492.1	603.2	615.9	4	7	280	1.36
711	493	330.2	660.4	327.0	542.9	654.0	666.7	4	7	270	1.48

Note) The Permissible Load and Mass each indicate when used as a pair of 2 units.

Model number coding

FBL35S-P14 +559L

Model number

Overall rail length (mm)

Model FBL 35M

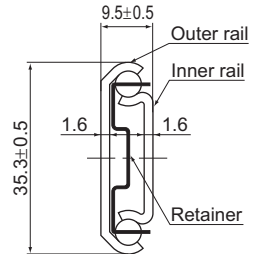
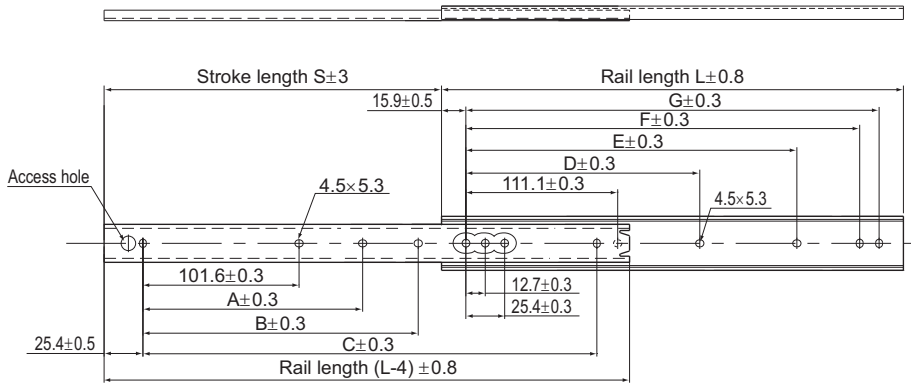

Cross section

Unit: mm

Rail length L (±0.8)	Stroke S (±3)	Mounting hole dimensions							Mounting hole		Permissible load N/pair	Mass kg/pair
		A	B	C	D	E	F	G	Inner rail	Outer rail		
305	229	—	152.4	254.0	—	149.2	260.3	273.0	4	7	490	0.6
356	279	—	203.2	304.8	—	200.0	311.1	323.8	4	7	400	0.7
406	305	—	254.0	355.6	—	250.8	361.9	374.6	4	7	390	0.8
457	330	203.2	304.8	406.4	212.7	301.6	412.7	425.4	5	8	380	0.9
508	381	228.6	355.6	457.2	238.1	352.4	463.5	476.2	5	8	330	1.0
559	406	254.0	406.4	508.0	263.5	403.2	514.3	527.0	5	8	320	1.1
610	432	279.4	457.2	558.8	288.9	454.0	565.1	577.8	5	8	310	1.2
660	483	304.8	508.0	609.6	314.3	504.8	615.9	628.6	5	8	280	1.3
711	508	330.2	558.8	660.4	339.7	555.6	666.7	679.4	5	8	270	1.4

Note) The Permissible Load and Mass each indicate when used as a pair of 2 units.

Model number coding

FBL35M +406L

Model number Overall rail length (mm)

Model FBL 35J

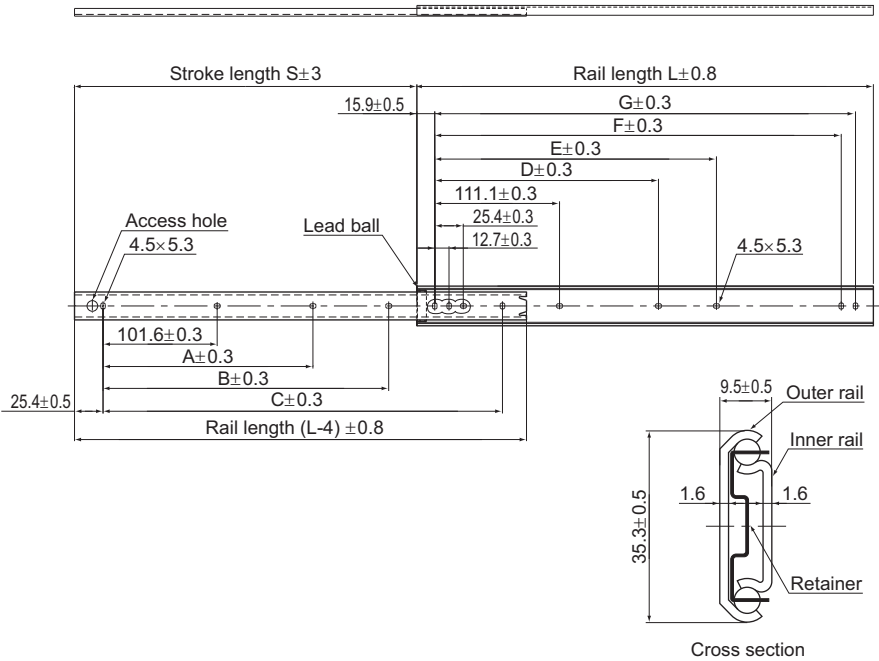

Unit: mm

Rail length L (±0.8)	Stroke S (±3)	Mounting hole dimensions							Mounting hole		Permissible load N/pair	Mass kg/pair
		A	B	C	D	E	F	G	Inner rail	Outer rail		
305	229	—	152.4	254.0	—	149.2	260.3	273.0	4	7	490	0.6
356	279	—	203.2	304.8	—	200.0	311.1	323.8	4	7	400	0.7
406	305	—	254.0	355.6	—	250.8	361.9	374.6	4	7	390	0.8
457	330	203.2	304.8	406.4	212.7	301.6	412.7	425.4	5	8	380	0.9
508	381	228.6	355.6	457.2	238.1	352.4	463.5	476.2	5	8	330	1.0
559	406	254.0	406.4	508.0	263.5	403.2	514.3	527.0	5	8	320	1.1
610	432	279.4	457.2	558.8	288.9	454.0	565.1	577.8	5	8	310	1.2
660	483	304.8	508.0	609.6	314.3	504.8	615.9	628.6	5	8	280	1.3
711	508	330.2	558.8	660.4	339.7	555.6	666.7	679.4	5	8	270	1.4

Note) The Permissible Load and Mass each indicate when used as a pair of 2 units.

Model number coding

FBL35J +660L

Model number Overall rail length (mm)

Model FBL 35B

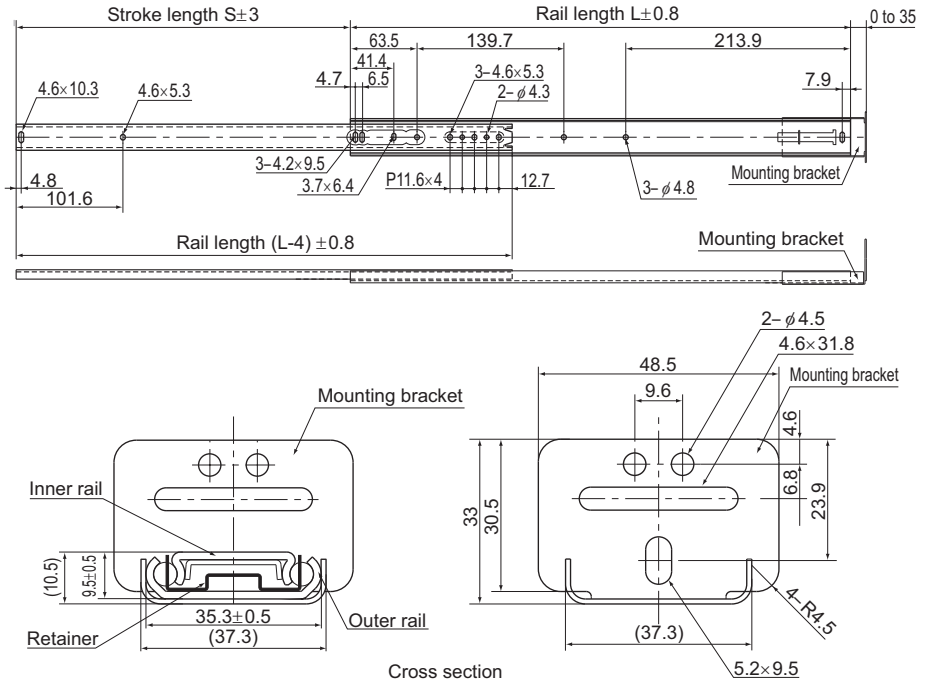

Unit: mm

Rail length L (±0.8)	Stroke S (±3)	Mounting hole		Permissible load N/pair	Mass kg/pair
		Inner rail	Outer rail		
324	216	7	7	115	0.8
375	267	7	7	105	0.92
425	305	7	7	100	1
476	318	7	7	90	1.12
527	368	7	7	83	1.24
578	419	7	7	73	1.32
629	445	7	7	66	1.44
679	495	7	7	61	1.6

Note) The Permissible Load and Mass each indicate when used as a pair of 2 units.

Model number coding

FBL35B +375L

Model number Overall rail length (mm)

Slide Rail

Model FBL 35T

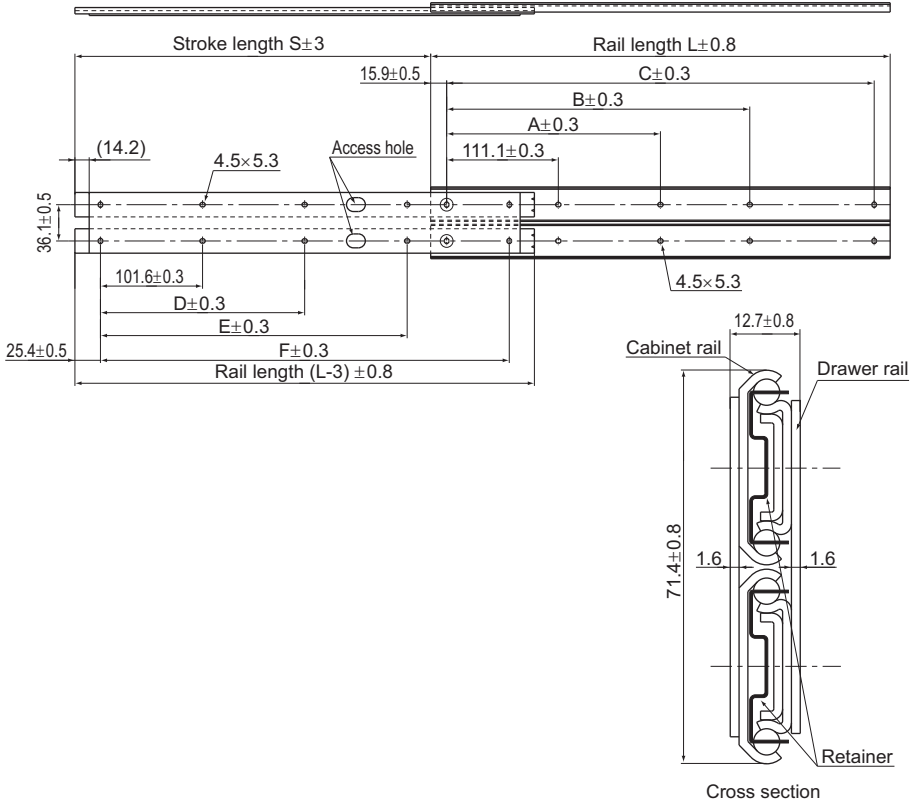

Unit: mm

Rail length L (±0.8)	Stroke S (±3)	Mounting hole dimensions						Mounting hole		Permissible load N/pair	Mass kg/pair
		A	B	C	D	E	F	Inner rail	Outer rail		
305	227	—	149.2	273.0	—	152.8	254.4	4	4	1120	2.16
356	278	—	200.0	323.8	—	203.6	305.2	4	4	1070	2.56
406	303	—	250.8	374.6	—	254.4	356.0	4	4	1020	2.96
457	354	212.7	301.6	425.4	203.2	305.2	406.8	5	5	1000	3.3
508	367	238.1	352.4	476.2	228.6	356.0	457.6	5	5	971	3.64
559	430	263.5	403.2	527.0	254.0	406.8	508.4	5	5	922	4.04
610	456	288.9	454.0	577.8	279.4	457.6	559.2	5	5	873	4.32
660	468	314.3	504.8	628.6	304.8	508.4	610.0	5	5	843	4.72
711	506	339.7	555.6	679.4	330.2	559.2	660.8	5	5	784	5.1

Note) The Permissible Load and Mass each indicate when used as a pair of 2 units.

Model number coding

FBL35T +559L

Model number Overall rail length (mm)

Model FBL 27D

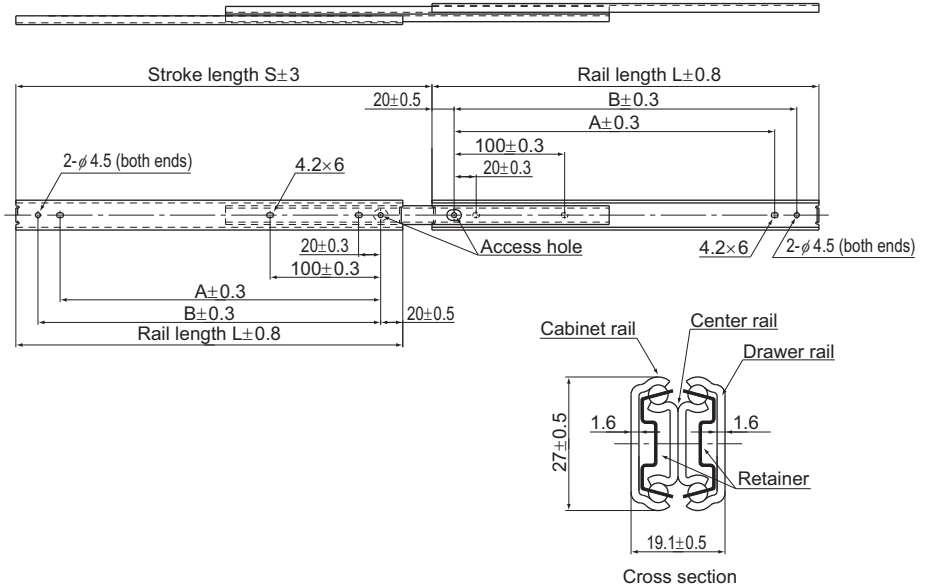

Unit: mm

Rail length L (±0.8)	Stroke S (±3)	Mounting hole dimensions		Mounting hole		Permissible load N/pair	Mass kg/pair
		A	B	Drawer rail	Cabinet rail		
200	229	140.0	160.0	5	5	370	0.64
250	276	190.0	210.0	5	5	360	0.8
300	327	240.0	260.0	5	5	350	0.96
350	376	290.0	310.0	5	5	330	1.12
400	426	340.0	360.0	5	5	310	1.28
450	475	390.0	410.0	5	5	290	1.46
500	524	440.0	460.0	5	5	280	1.6

Note) The Permissible Load and Mass each indicate when used as a pair of 2 units.

Model number coding

FBL27D +200L

Model number Overall rail length (mm)

Model FBL 35E

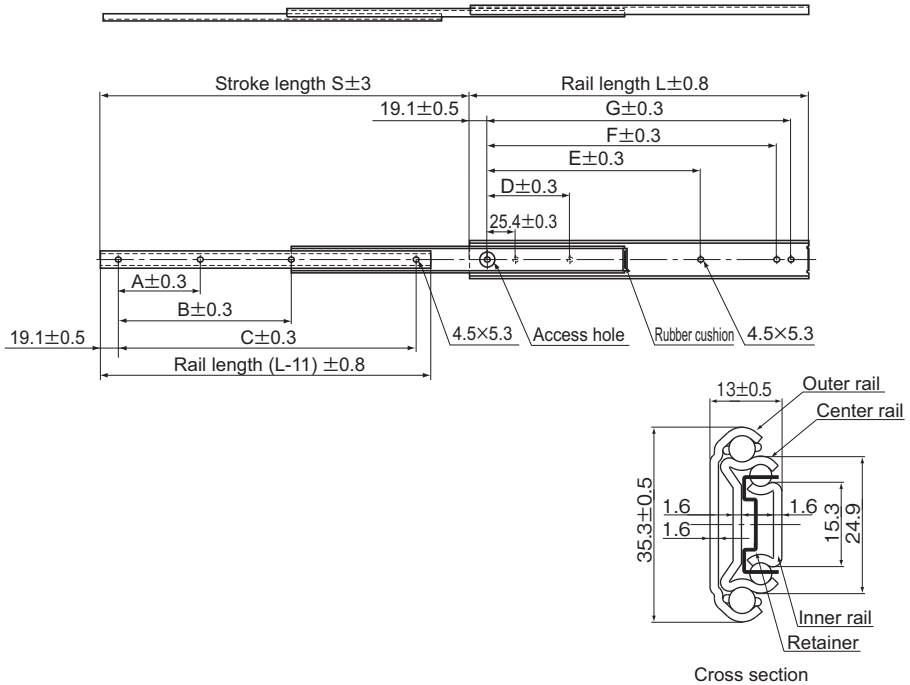

Cross section

Unit: mm

Rail length L (±0.8)	Stroke S (±3)	Mounting hole dimensions							Permissible load N/pair	Mass kg/pair
		A	B	C	D	E	F	G		
305	330	76.2	—	154.9	76.2	190.5	241.3	266.7	290	0.6
356	381	127	—	266.7	88.9	215.9	292.1	317.5	280	0.7
406	432	152.4	—	317.5	127	241.3	342.9	368.3	270	0.9
457	483	177.8	—	368.3	127	292.1	393.7	419.1	250	1.1
508	533	152.4	342.9	419.1	152.4	317.5	444.5	469.9	240	1.3

Note1) To mount model FBL35E, use an M3 truss and binding machine screws.

Note2) The Permissible Load and Mass each indicate when used as a pair of 2 units.

Model number coding

FBL35E +406L

Model No.

Overall rail length (mm)

Model FBL 35E-P14

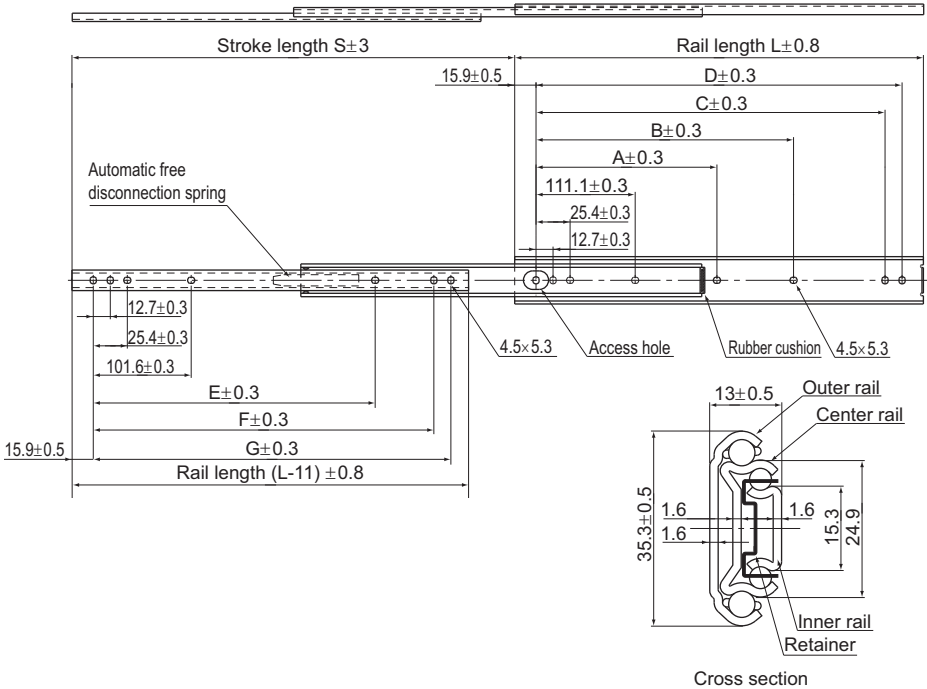

Unit: mm

Rail length L (±0.8)	Stroke S (±3)	Mounting hole dimensions							Mounting hole		Permissible load N/pair	Mass kg/pair
		A	B	C	D	E	F	G	Inner rail	Outer rail		
305	330	—	149.2	260.3	273.0	233.1	254.0	266.7	7	7	294	0.88
356	381	—	200.0	311.1	323.8	258.5	304.8	317.5	7	7	284	1.04
406	432	—	250.8	361.9	374.6	283.9	355.6	368.3	7	7	275	1.16
457	483	212.7	301.6	412.7	425.4	309.3	406.4	419.1	7	8	255	1.32
508	533	238.1	352.4	463.5	476.2	334.7	457.2	469.9	7	8	235	1.48

Note) The Permissible Load and Mass each indicate when used as a pair of 2 units.

Model number coding

FBL35E-P14 +508L

Model number

Overall rail length (mm)

Slide Rail

Model FBL 35G-P13

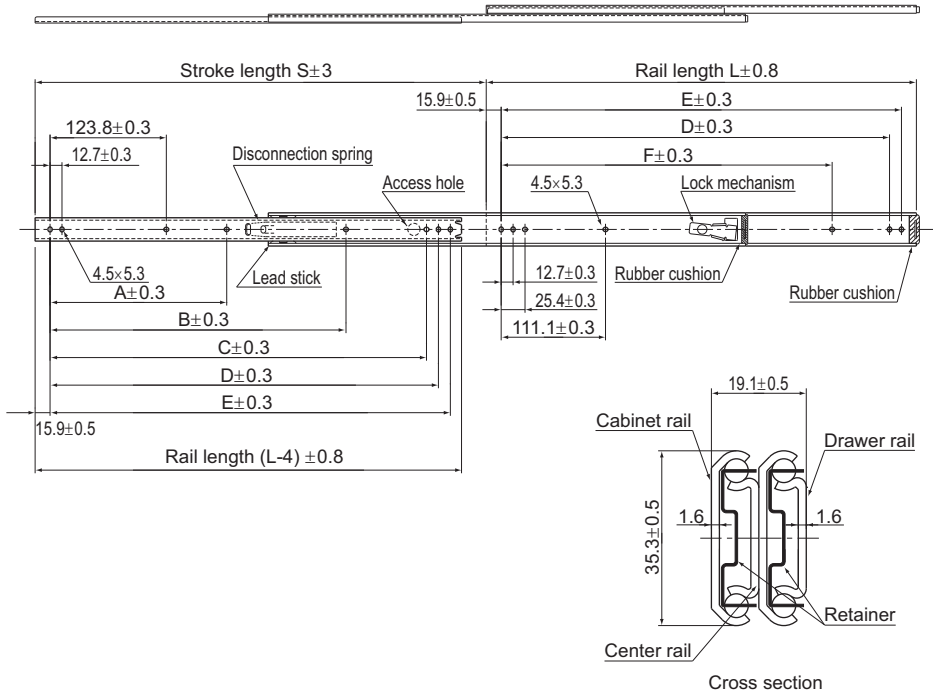

Unit: mm

Rail length L (±0.8)	Stroke S (±3)	Mounting hole dimensions						Mounting hole		Permissible load N/pair	Mass kg/pair
		A	B	C	D	E	F	Drawer rail	Cabinet rail		
305	327	—	—	—	260.3	273.0	—	5	6	623	1.2
356	378	—	—	298.4	311.1	323.8	—	6	6	586	1.4
406	429	—	—	349.2	361.9	374.6	250.8	6	7	555	1.6
457	480	212.7	—	400.0	412.7	425.4	301.6	7	7	516	1.8
508	530	238.1	365.1	450.8	463.5	476.2	352.4	8	7	475	2
559	581	263.5	415.9	501.6	514.3	527.0	403.2	8	7	444	2.2
610	632	288.9	466.7	552.4	565.1	577.8	454.0	8	7	413	2.4
660	683	314.3	517.5	603.2	615.9	628.6	504.8	8	7	382	2.6
711	734	339.7	568.3	654.0	666.7	679.4	555.6	8	7	355	2.8

Note) The Permissible Load and Mass each indicate when used as a pair of 2 units.

Model number coding

FBL35G-P13 +356L

Model number

Overall rail length (mm)

Model FBL 35G-P14

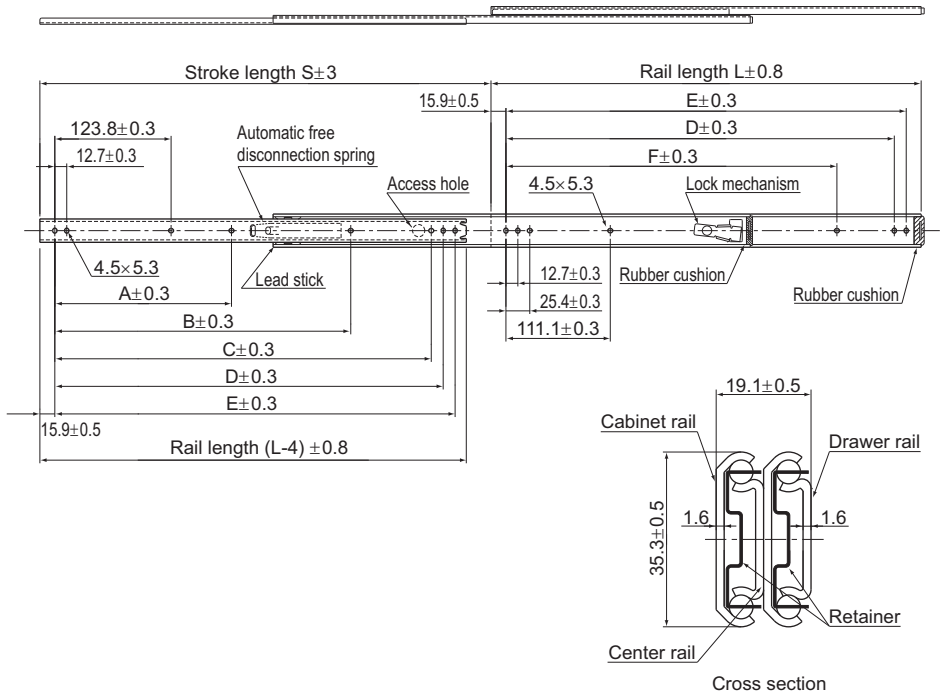

Unit: mm

Rail length L (±0.8)	Stroke S (±3)	Mounting hole dimensions						Mounting hole		Permissible load N/pair	Mass kg/pair
		A	B	C	D	E	F	Drawer rail	Cabinet rail		
305	327	—	—	—	260.3	273.0	—	5	6	623	1.2
356	378	—	—	298.4	311.1	323.8	—	6	6	586	1.4
406	429	—	—	349.2	361.9	374.6	250.8	6	7	555	1.6
457	480	212.7	—	400.0	412.7	425.4	301.6	7	7	516	1.8
508	530	238.1	365.1	450.8	463.5	476.2	352.4	8	7	475	2
559	581	263.5	415.9	501.6	514.3	527.0	403.2	8	7	444	2.2
610	632	288.9	466.7	552.4	565.1	577.8	454.0	8	7	413	2.4
660	683	314.3	517.5	603.2	615.9	628.6	504.8	8	7	382	2.6
711	734	339.7	568.3	654.0	666.7	679.4	555.6	8	7	355	2.8

Note) The Permissible Load and Mass each indicate when used as a pair of 2 units.

Model number coding

FBL35G-P14 +610L

Model number Overall rail length (mm)

Slide Rail

Model FBL 35D

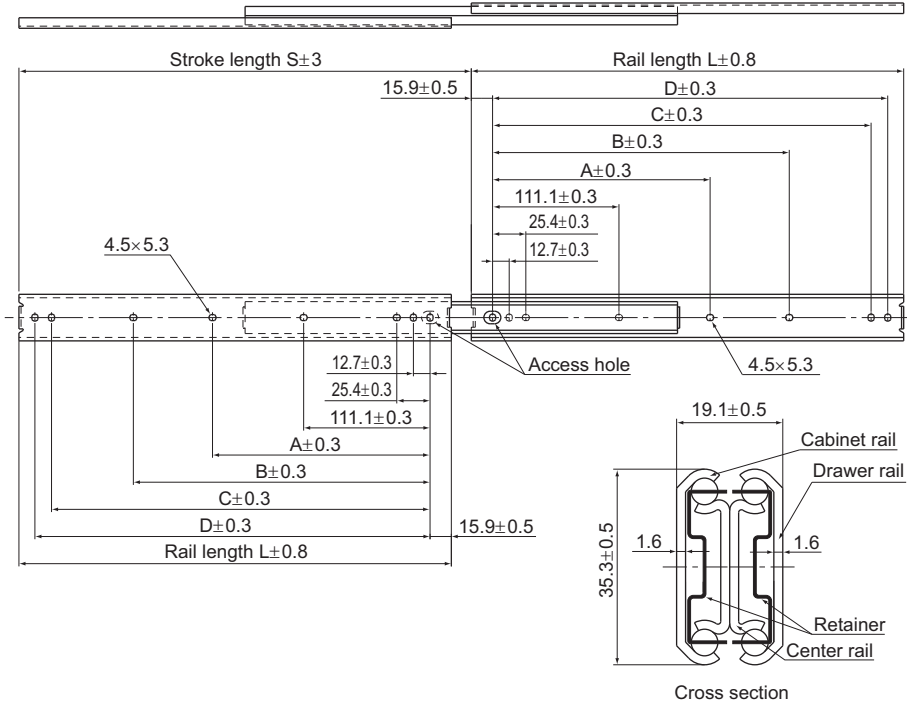

Unit: mm

Rail length L (± 0.8)	Stroke S (± 3)	Mounting hole dimensions				Mounting hole		Permissible load N/pair	Mass kg/pair
		A	B	C	D	Drawer rail	Cabinet rail		
305	327	—	149.2	260.3	273.0	7	7	588	1.28
356	378	—	200.0	311.1	323.8	7	7	578	1.48
406	429	—	250.8	361.9	374.6	7	7	559	1.72
457	480	212.7	301.6	412.7	425.4	8	8	549	1.96
508	530	238.1	352.4	463.5	476.2	8	8	529	2.12
559	581	263.5	403.2	514.3	527.0	8	8	500	2.4
610	632	288.9	454.0	565.1	577.8	8	8	480	2.56
660	683	314.3	504.8	615.9	628.6	8	8	461	2.8
711	734	339.7	555.6	666.7	679.4	8	8	441	3

Note) The Permissible Load and Mass each indicate when used as a pair of 2 units.

Model number coding

FBL35D +711L

Model number Overall rail length (mm)

Model FBL 51H

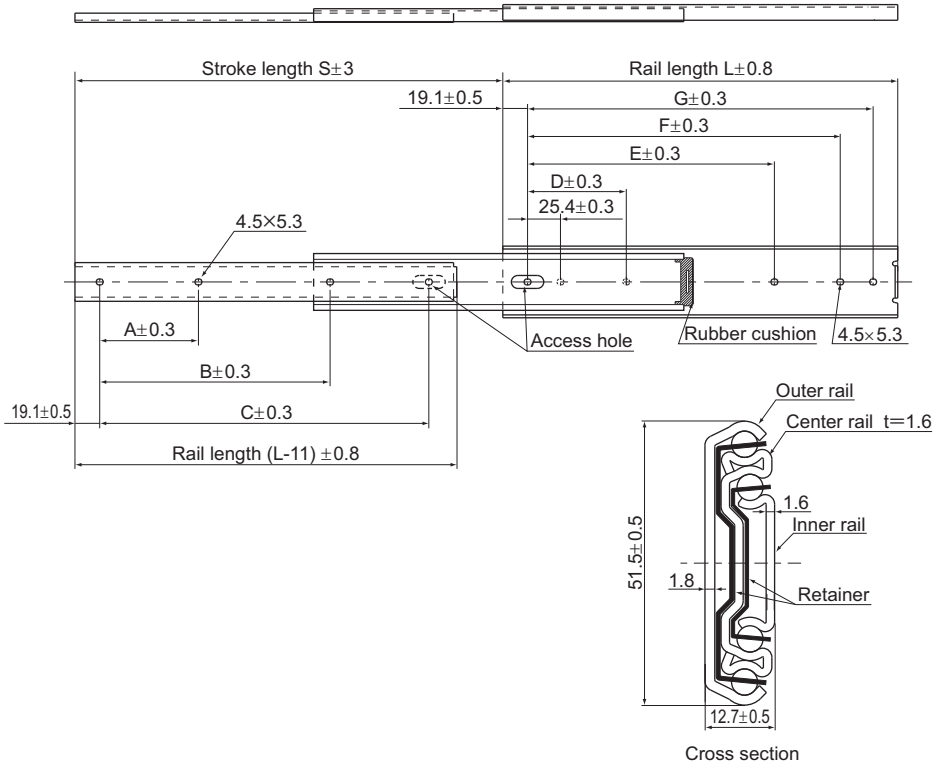

Unit: mm

Rail length L (±0.8)	Stroke S (±3)	Mounting hole dimensions							Mounting hole		Permissible load N/pair	Mass kg/pair
		A	B	C	D	E	F	G	Inner rail	Outer rail		
305	330	76.2	177.8	254.0	76.2	190.5	241.3	266.7	4	6	850	1.46
356	381	101.6	203.2	304.8	88.9	215.9	292.1	317.5	4	6	820	1.72
406	432	127.0	228.6	355.6	127.0	241.3	342.9	368.3	4	6	770	1.89
457	483	127.0	279.4	406.4	127.0	292.1	393.7	419.1	4	6	730	2.26
508	533	152.4	304.8	457.2	152.4	317.5	444.5	469.9	4	6	710	2.52
559	584	177.8	330.2	508.0	177.8	342.9	495.3	520.7	4	6	690	2.72
610	635	177.8	381.0	558.8	177.8	393.7	546.1	571.5	4	6	660	3.00
660	686	203.2	406.4	609.6	203.2	419.1	596.9	622.3	4	6	630	3.25
711	737	228.6	431.8	660.4	228.6	444.5	647.7	673.1	4	6	610	3.54
762	787	228.6	457.2	711.2	228.6	469.9	698.5	723.9	4	6	580	3.86

Note) The Permissible Load and Mass each indicate when used as a pair of 2 units.

Model number coding

FBL51H +610L

Model number Overall rail length (mm)

Model FBL 51H-P13

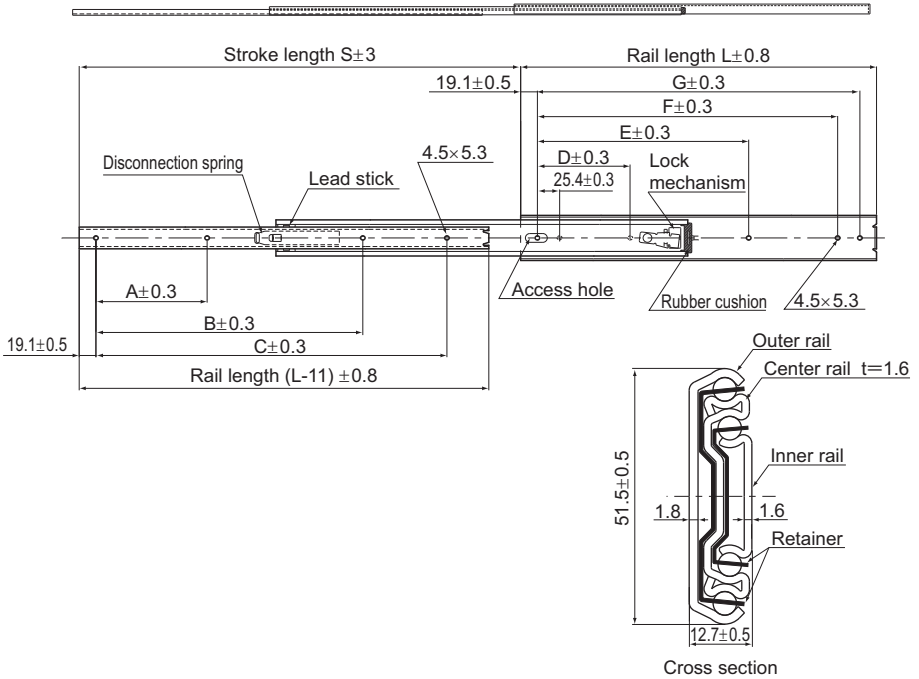

Unit: mm

Rail length L (±0.8)	Stroke S (±3)	Mounting hole dimensions							Mounting hole		Permissible load N/pair	Mass kg/pair
		A	B	C	D	E	F	G	Inner rail	Outer rail		
305	330	76.2	—	190.5	76.2	190.5	241.3	266.7	3	6	850	1.46
356	381	101.6	—	266.7	88.9	215.9	292.1	317.5	3	6	820	1.72
406	432	127.0	—	304.8	127.0	241.3	342.9	368.3	3	6	770	1.89
457	483	127.0	317.5	368.3	127.0	292.1	393.7	419.1	4	6	730	2.26
508	533	152.4	355.6	406.4	152.4	317.5	444.5	469.9	4	6	710	2.52
559	584	177.8	381.0	457.2	177.8	342.9	495.3	520.7	4	6	690	2.72
610	635	177.8	430.8	508.0	177.8	393.7	546.1	571.5	4	6	660	3.00
660	686	203.2	457.2	558.8	203.2	419.1	596.9	622.3	4	6	630	3.25
711	737	228.6	508.0	609.6	228.6	444.5	647.7	673.1	4	6	610	3.54
762	787	228.6	533.4	660.4	228.6	469.9	698.5	723.9	4	6	580	3.86

Note) The Permissible Load and Mass each indicate when used as a pair of 2 units.

Model number coding

FBL51H-P13 +559L

Model number

Overall rail length (mm)

Slide Rail

Model FBL 51H-P14

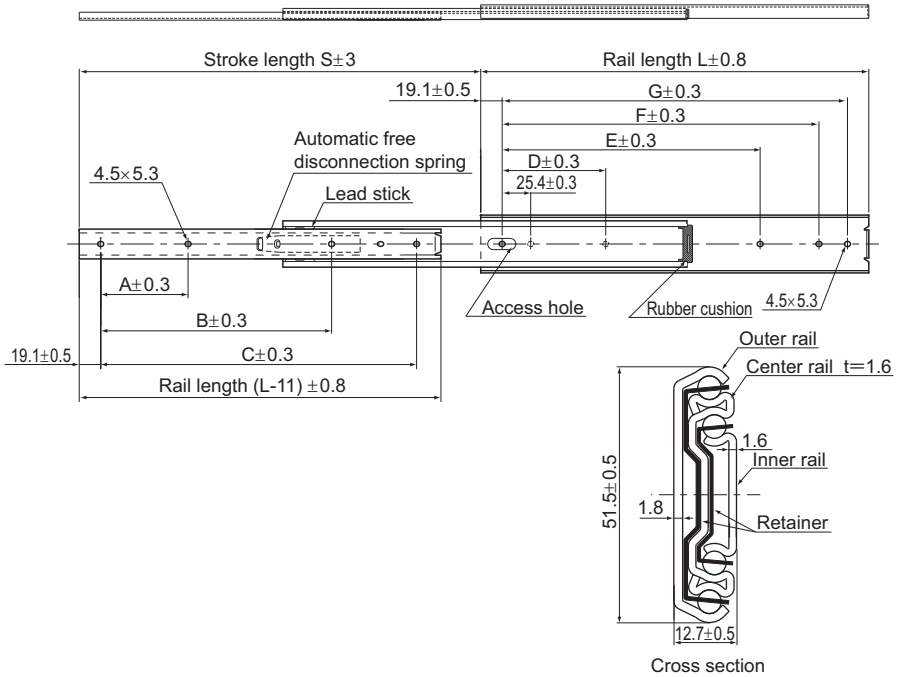

Unit: mm

Rail length L (±0.8)	Stroke S (±3)	Mounting hole dimensions							Mounting hole		Permissible load N/pair	Mass kg/pair
		A	B	C	D	E	F	G	Inner rail	Outer rail		
305	330	76.2	—	254.0	76.2	190.5	241.3	266.7	3	6	850	1.46
356	381	127.0	—	304.8	88.9	215.9	292.1	317.5	3	6	820	1.72
406	432	152.4	317.5	355.6	127.0	241.3	342.9	368.3	4	6	770	1.89
457	483	177.8	368.3	406.4	127.0	292.1	393.7	419.1	4	6	730	2.26
508	533	152.4	419.1	457.2	152.4	317.5	444.5	469.9	4	6	710	2.52
559	584	177.8	469.9	508.0	177.8	342.9	495.3	520.7	4	6	690	2.72
610	635	177.8	520.7	558.8	177.8	393.7	546.1	571.5	4	6	660	3.00
660	686	203.2	571.5	609.6	203.2	419.1	596.9	622.3	4	6	630	3.25
711	737	228.6	622.3	660.4	228.6	444.5	647.7	673.1	4	6	610	3.54
762	787	228.6	673.1	711.2	228.6	469.9	698.5	723.9	4	6	580	3.86

Note) The Permissible Load and Mass each indicate when used as a pair of 2 units.

Model number coding

FBL51H-P14 +305L

Model number

Overall rail length (mm)

Model FBL 35K

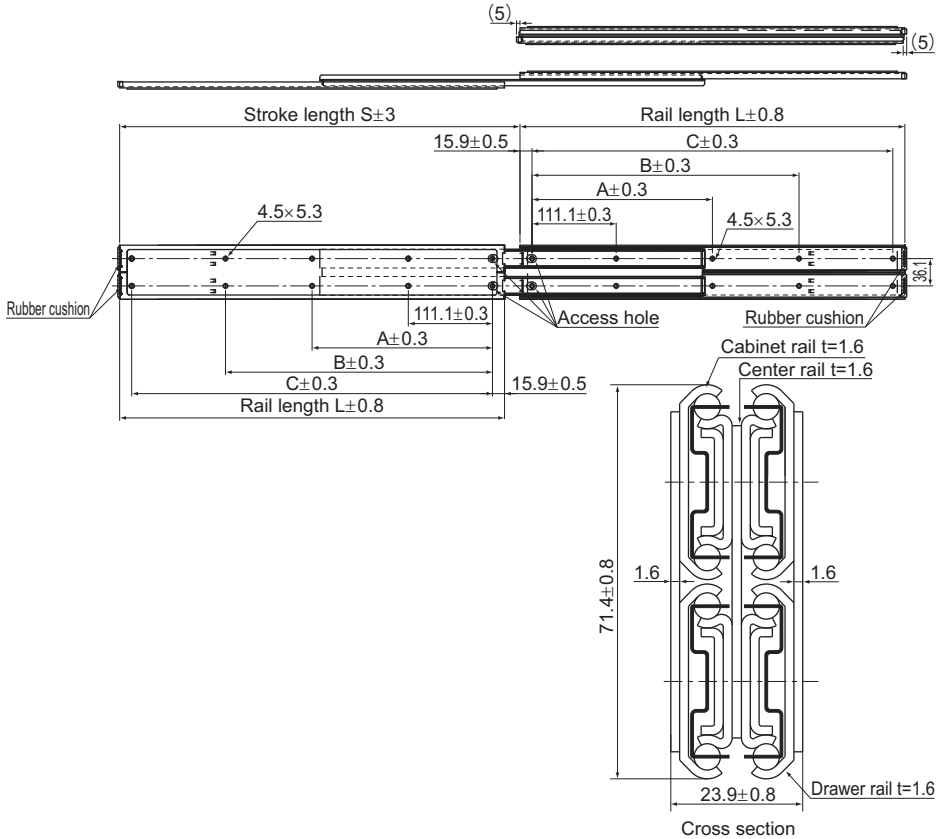

Note) The product has a rubber cushion.
 If desiring to keep the length within the rail length when storing the product, remove the rubber cushion.

Unit: mm

Rail length L (± 0.8)	Stroke S (± 3)	Mounting hole dimensions			Mounting hole		Permissible load N/pair	Mass kg/pair
		A	B	C	Drawer rail	Cabinet rail		
305	327	—	149.2	273.0	4	4	2670	4.04
356	378	—	200.0	323.8	4	4	2630	4.8
406	429	—	250.8	374.6	4	4	2540	5.6
457	480	212.7	301.6	425.4	5	5	2450	6.04
508	530	238.1	352.4	476.2	5	5	2360	6.92
559	581	263.5	403.2	527.0	5	5	2250	7.56
610	632	288.9	454.0	577.8	5	5	2120	8.4
660	683	314.3	504.8	628.6	5	5	1960	9
711	734	339.7	555.6	679.4	5	5	1780	9.68

Note) The Permissible Load and Mass each indicate when used as a pair of 2 units.

Model number coding

FBL35K +711L

Model number Overall rail length (mm)

Model FBL 56H

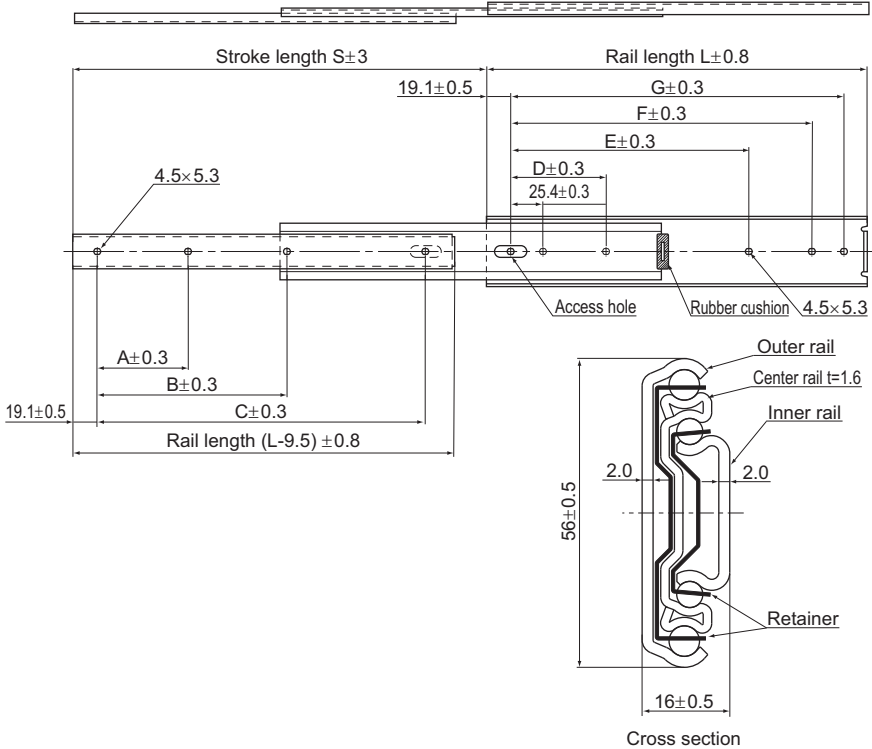

Unit: mm

Rail length L (± 0.8)	Stroke S (± 3)	Mounting hole dimensions							Mounting hole		Permissible load N/pair	Mass kg/pair
		A	B	C	D	E	F	G	Inner rail	Outer rail		
305	330	76.2	177.8	254.0	76.2	190.5	241.3	266.7	4	6	961	1.76
356	381	101.6	203.2	304.8	88.9	215.9	292.1	317.5	4	6	951	2.04
406	432	127.0	228.6	355.6	127.0	241.3	342.9	368.3	4	6	941	2.36
457	483	127.0	279.4	406.4	127.0	292.1	393.7	419.1	4	6	922	2.64
508	533	152.4	304.8	457.2	152.4	317.5	444.5	469.9	4	6	902	2.96
559	584	177.8	330.2	508.0	177.8	342.9	495.3	520.7	4	6	882	3.24
610	635	177.8	381.0	558.8	177.8	393.7	546.1	571.5	4	6	863	3.6
660	686	203.2	406.4	609.6	203.2	419.1	596.9	622.3	4	6	843	3.84
711	737	228.6	431.8	660.4	228.6	444.5	647.7	673.1	4	6	824	4.06
762	787	228.6	457.2	711.2	228.6	469.9	698.5	723.9	4	6	784	4.44

Note) The Permissible Load and Mass each indicate when used as a pair of 2 units.

Model number coding

FBL56H +406L

Model number Overall rail length (mm)

Model FBL 56H-P13

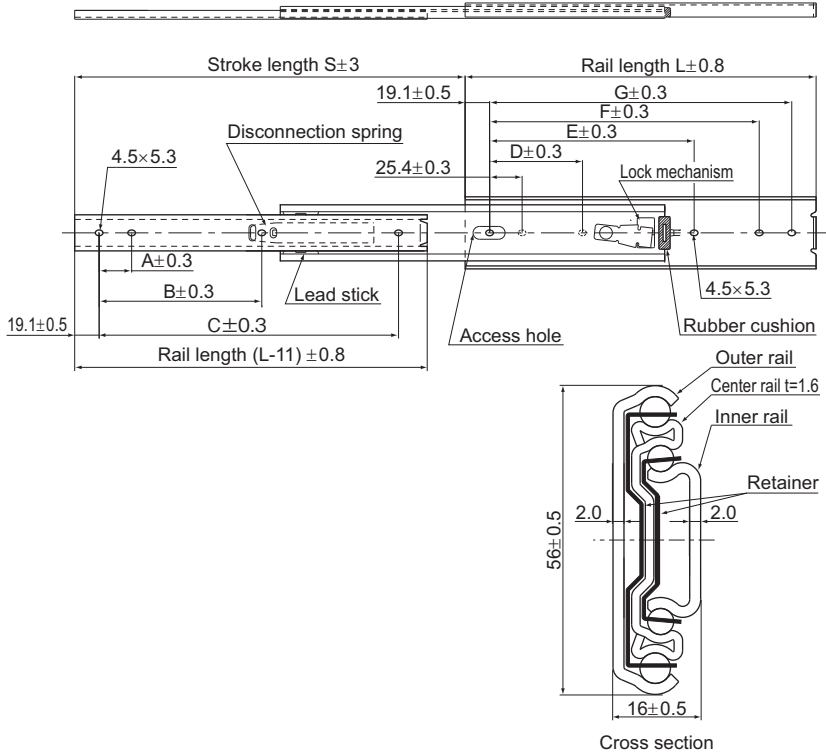

Unit: mm

Rail length L (±0.8)	Stroke S (±3)	Mounting hole dimensions							Mounting hole		Permissible load N/pair	Mass kg/pair
		A	B	C	D	E	F	G	Inner rail	Outer rail		
305	330	76.2	—	254.0	76.2	190.5	241.3	266.7	3	6	961	1.76
356	381	127.0	—	304.8	88.9	215.9	292.1	317.5	3	6	951	2.04
406	432	152.4	317.5	355.6	127.0	241.3	342.9	368.3	4	6	941	2.36
457	483	177.8	368.3	406.4	127.0	292.1	393.7	419.1	4	6	922	2.64
508	533	152.4	419.1	457.2	152.4	317.5	444.5	469.9	4	6	902	2.96
559	584	177.8	469.9	508.0	177.8	342.9	495.3	520.7	4	6	882	3.24
610	635	177.8	520.7	558.8	177.8	393.7	546.1	571.5	4	6	863	3.6
660	686	203.2	571.5	609.6	203.2	419.1	596.9	622.3	4	6	843	3.84
711	737	228.6	622.3	660.4	228.6	444.5	647.7	673.1	4	6	824	4.06
762	787	228.6	673.1	711.2	228.6	469.9	698.5	723.9	4	6	784	4.44

Note) The Permissible Load and Mass each indicate when used as a pair of 2 units.

Model number coding

FBL56H-P13 +762L

Model number

Overall rail length (mm)

Model FBL 56H-P14

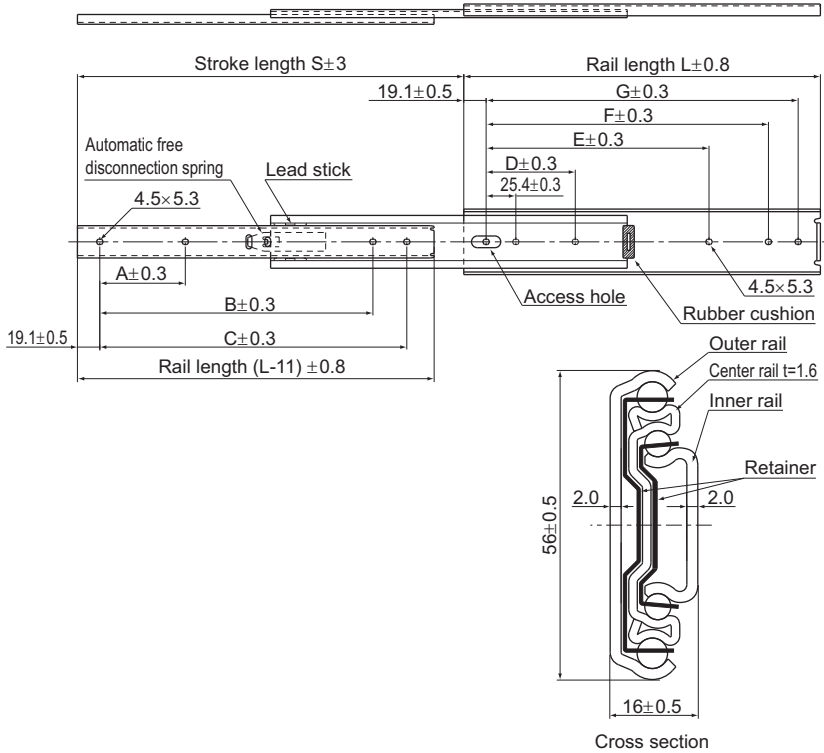

Unit: mm

Rail length L (±0.8)	Stroke S (±3)	Mounting hole dimensions							Mounting hole		Permissible load N/pair	Mass kg/pair
		A	B	C	D	E	F	G	Inner rail	Outer rail		
305	330	76.2	—	254.0	76.2	190.5	241.3	266.7	3	6	961	1.76
356	381	127.0	—	304.8	88.9	215.9	292.1	317.5	3	6	951	2.04
406	432	152.4	317.5	355.6	127.0	241.3	342.9	368.3	4	6	941	2.36
457	483	177.8	368.3	406.4	127.0	292.1	393.7	419.1	4	6	922	2.64
508	533	152.4	419.1	457.2	152.4	317.5	444.5	469.9	4	6	902	2.96
559	584	177.8	469.9	508.0	177.8	342.9	495.3	520.7	4	6	882	3.24
610	635	177.8	520.7	558.8	177.8	393.7	546.1	571.5	4	6	863	3.6
660	686	203.2	571.5	609.6	203.2	419.1	596.9	622.3	4	6	843	3.84
711	737	228.6	622.3	660.4	228.6	444.5	647.7	673.1	4	6	824	4.06
762	787	228.6	673.1	711.2	228.6	469.9	698.5	723.9	4	6	784	4.44

Note) The Permissible Load and Mass each indicate when used as a pair of 2 units.

Model number coding

FBL56H-P14 +457L

Model number

Overall rail length (mm)

Model FBL 35F

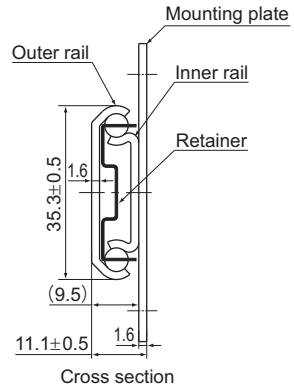
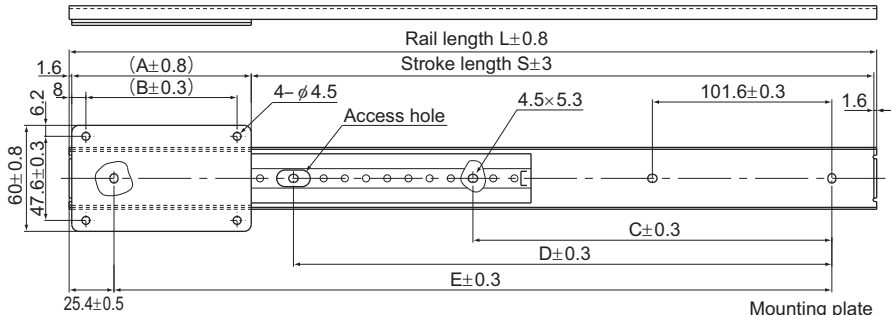

Rail length L (±0.8) mm	Mass					
	Unit: kg/pair					
Rail length L (±0.8) mm	Mounting plate Model No.					
	#3	#4	#5	#6	#7	#8
305	0.60	0.67	0.74	0.81	—	—
356	0.66	0.73	0.80	0.87	0.94	1.01
406	0.73	0.80	0.87	0.94	1.01	1.08
457	0.80	0.87	0.94	1.01	1.08	1.15
508	0.86	0.93	1.0	1.07	1.14	1.21
559	0.93	1.0	1.07	1.14	1.21	1.28
610	1.0	1.07	1.14	1.21	1.28	1.35
660	1.06	1.13	1.20	1.27	1.34	1.41
711	1.13	1.20	1.27	1.34	1.41	1.48
762	1.20	1.27	1.34	1.41	1.48	1.55

Note) The mass indicates the value for a pair of 2 product units.

Unit: mm

Mounting plate	Model No.	#3	#4	#5	#6	#7	#8	Dimension of the outer rail mounting hole (±0.3)		
	Length (A±0.8)	76.2	101.6	127	152.4	177.8	203.2	C	D	E
Rail length L (±0.8)		Stroke length S (±3) *Varies with the combination with the mounting plate above.						C	D	E
305		225.4	200.0	174.6	149.2	—	—	—	152.4	254.0
356		276.2	250.8	225.4	200.0	174.6	149.2	—	203.2	304.8
406		327.0	301.6	276.2	250.8	225.4	200.0	—	254.0	355.6
457		377.8	352.4	327.0	301.6	276.2	250.8	203.2	304.8	406.4
508		428.6	403.2	377.8	352.4	327.0	301.6	228.6	355.6	457.2
559		479.4	454.0	428.6	403.2	377.8	352.4	254.0	406.4	508.0
610		530.2	504.8	479.4	454.0	428.6	403.2	279.4	457.2	558.8
660		581.0	555.6	530.2	504.8	479.4	454.0	304.8	508.0	609.6
711		631.8	606.4	581.0	555.6	530.2	504.8	330.2	558.8	660.4
762		682.6	657.2	631.8	606.4	581.0	555.6	355.6	609.6	711.2
Pitch of the mounting plate mounting hole (B±0.3)		60.2	85.6	111.0	136.4	161.8	187.2	—	—	—
Permissible load (N/pair)		294	392	490	588	686	784	—	—	—

Note) The Permissible Load and Mass each indicate when used as a pair of 2 units.

Model number coding

FBL35F +356L #5

Model number

Model number of mounting plate

Overall rail length (mm)

Model FBL 56F

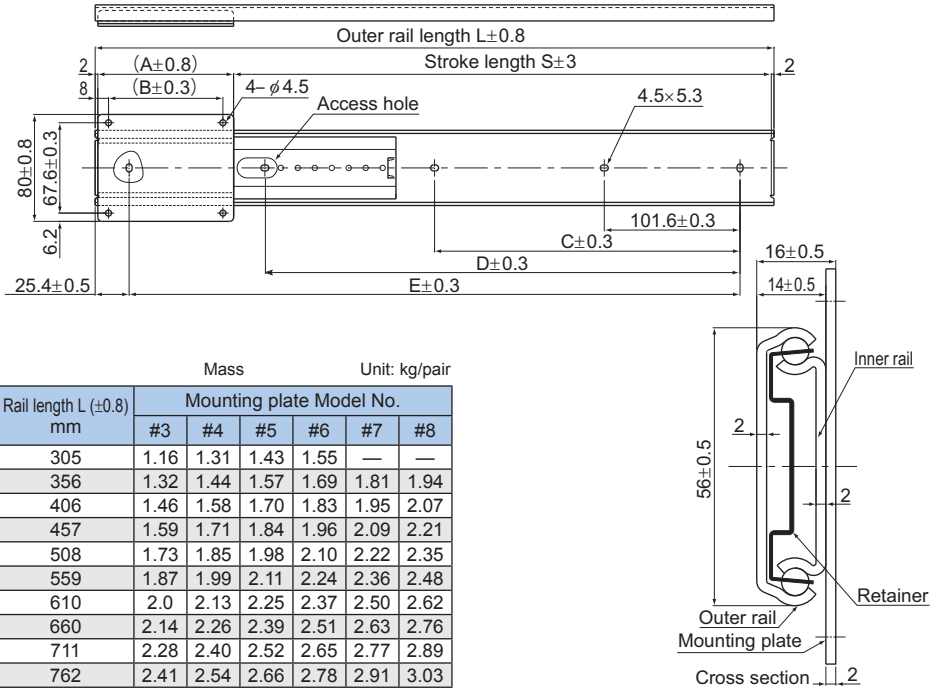

Mass Unit: kg/pair

Rail length L (±0.8) mm	Mounting plate Model No.					
	#3	#4	#5	#6	#7	#8
305	1.16	1.31	1.43	1.55	—	—
356	1.32	1.44	1.57	1.69	1.81	1.94
406	1.46	1.58	1.70	1.83	1.95	2.07
457	1.59	1.71	1.84	1.96	2.09	2.21
508	1.73	1.85	1.98	2.10	2.22	2.35
559	1.87	1.99	2.11	2.24	2.36	2.48
610	2.0	2.13	2.25	2.37	2.50	2.62
660	2.14	2.26	2.39	2.51	2.63	2.76
711	2.28	2.40	2.52	2.65	2.77	2.89
762	2.41	2.54	2.66	2.78	2.91	3.03

Note) The mass indicates the value for a pair of 2 product units.

Unit: mm

Mounting plate	Model No.	#3	#4	#5	#6	#7	#8	Dimension of the outer rail mounting hole (±0.3)		
	Length (A±0.8)	76.2	101.6	127	152.4	177.8	203.2	C	D	E
Rail length L (±0.8)		Stroke length S (±3) *Varies with the combination with the mounting plate above.						C	D	E
305		224.6	199.2	173.8	148.4	—	—	—	152.4	254.0
356		275.4	250.0	224.6	199.2	173.8	148.4	—	203.2	304.8
406		326.2	300.8	275.4	250.0	224.6	199.2	—	254.0	355.6
457		377.0	351.6	326.2	300.8	275.4	250.0	203.2	304.8	406.4
508		427.8	402.4	377.0	351.6	326.2	300.8	228.6	355.6	457.2
559		478.6	453.2	427.8	402.4	377.0	351.6	254.0	406.4	508.0
610		529.4	504.0	478.6	453.2	427.8	402.4	279.4	457.2	558.8
660		580.2	554.8	529.4	504.0	478.6	453.2	304.8	508.0	609.6
711		631.0	605.6	580.2	554.8	529.4	504.0	330.2	558.8	660.4
762		681.8	656.4	631.0	605.6	580.2	554.8	355.6	609.6	711.2
Pitch of the mounting plate mounting hole (B±0.3)		60.2	85.6	111.0	136.4	161.8	187.2	—	—	—
Permissible load (N/pair)		588	784	980	1176	1372	1568	—	—	—

Note) The Permissible Load and Mass each indicate when used as a pair of 2 units.

Model number coding

FBL56F +305L #6

Model number

Model number of mounting plate

Overall rail length (mm)

Model FBL 48DR

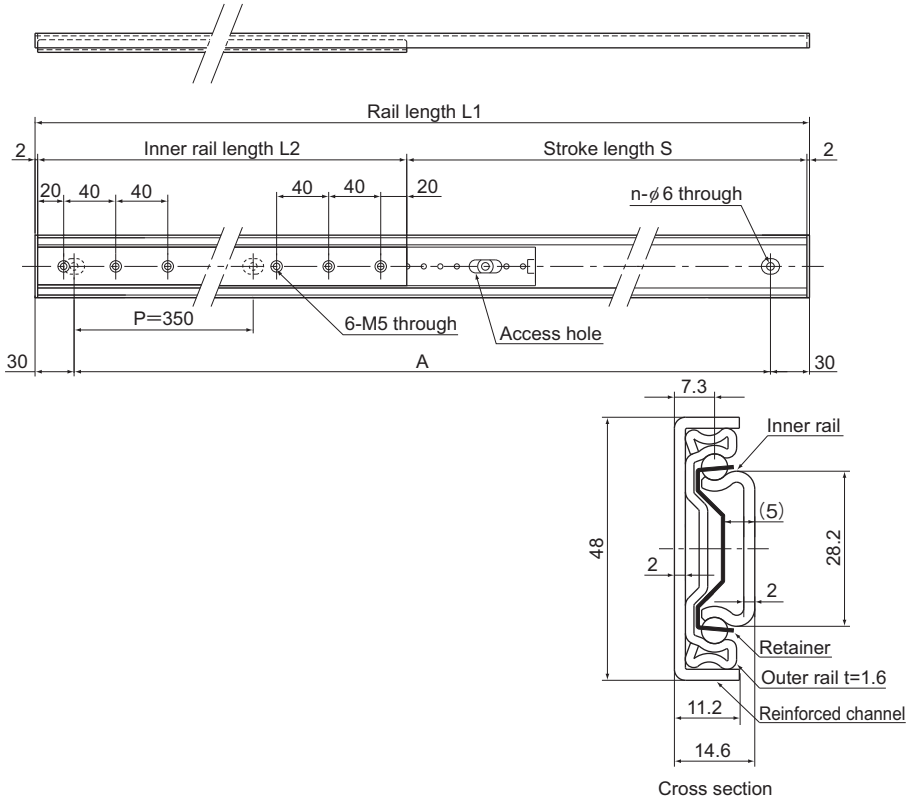

Unit: mm

Outer rail length L1	Inner rail length L2	Stroke length S	Mounting hole pitch A	No. of mounting holes n	Permissible load [N]	Mass [kg]
1110	496	610	P350×3	4	490	2.73
1110	696	410	P350×3	4	686	2.88
1460	496	960	P350×4	5	490	3.47
1460	696	760	P350×4	5	686	3.62
1810	696	1110	P350×5	6	686	4.36
2160	496	1660	P350×6	7	490	4.95
2160	696	1460	P350×6	7	686	5.10

Note1) Set the length of the mounting screws for the inner rail such that they do not touch the retainer.

Note2) Model FBL48DR differs from other slide rails by assuming use with a single rail. Therefore, the value is per single rail for permissible load.

Model number coding

FBL48DR +1810/696L

Model number

Outer rail length
L1 (mm)

Inner rail length
L2 (mm)

Model E36RS

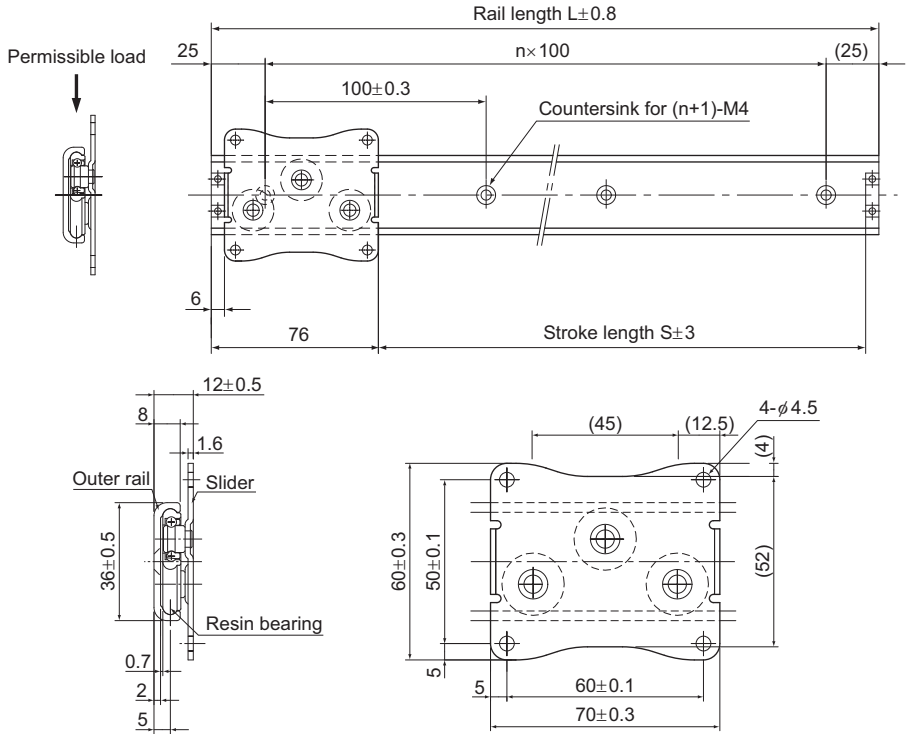

Unit: mm

Rail length $L (\pm 0.8)$	Stroke length $S (\pm 3)$	n	Mounting hole $n+1$	Permissible load ^(Note1) N	Mass g
150	68	1	2	40	104
250	168	2	3	40	130
350	268	3	4	40	156
450	368	4	5	40	182
550	468	5	6	40	207
650	568	6	7	40	233
750	668	7	8	40	259

Note) Model E36RS differs from other slide rails by assuming use with a single rail. Therefore, the value is per single rail for permissible load.

Model number coding

E36RS +550L

Model number Overall rail length (mm)

Model E15

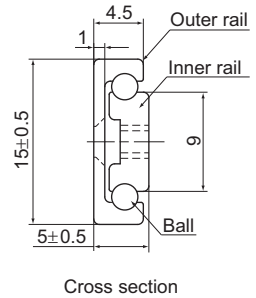
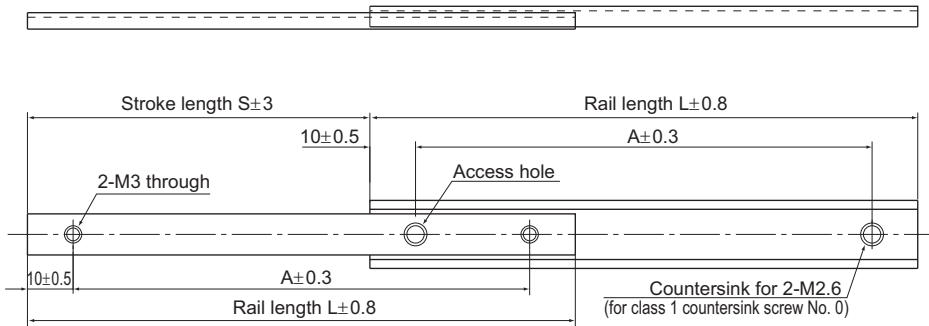

Unit: mm

Rail length $L (\pm 0.8)$	Stroke $S (\pm 3)$	Mounting hole dimensions $A \pm 0.3$	Permissible load N/pair	Mass $[\text{g}/\text{pair}]$
50	20	30.0	5	15
80	45	60.0	8	24
100	60	80.0	10	30
120	75	100.0	10	36

Note) The Permissible Load and Mass each indicate when used as a pair of 2 units.

Model number coding

E15 +100L

Model number Overall rail length (mm)

Model E20

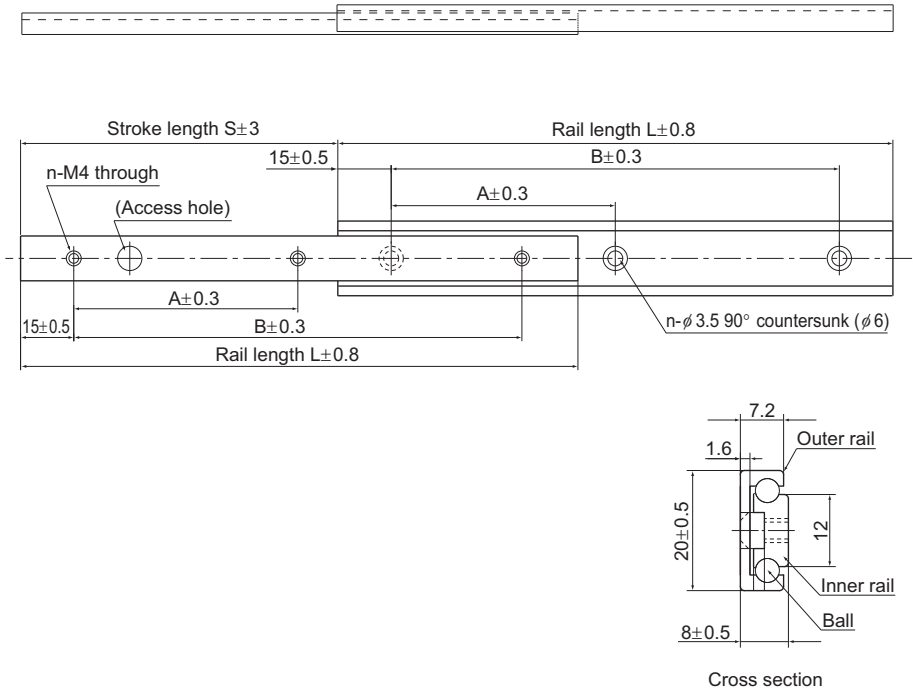

Unit: mm

Rail length $L (\pm 0.8)$	Stroke $S (\pm 3)$	Mounting hole dimensions			Permissible load N/pair	Mass [g/pair]
		$A \pm 0.3$	$B \pm 0.3$	n (pcs)		
80	45	50.0	—	2	20	50
100	60	70.0	—	2	30	62
150	85	60.0	120.0	3	80	98
200	120	85.0	170.0	3	140	131
300	180	135.0	270.0	3	145	197

Note) The Permissible Load and Mass each indicate when used as a pair of 2 units.

Model number coding

E20 +150L

Model number Overall rail length (mm)

Model D20

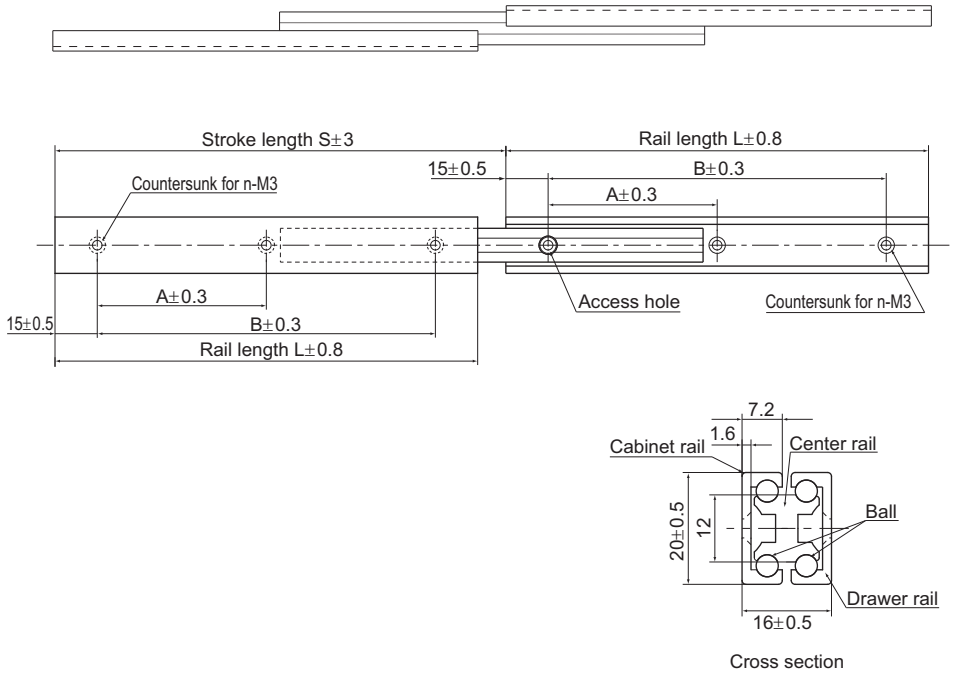

Unit: mm

Rail length $L (\pm 0.8)$	Stroke $S (\pm 3)$	Mounting hole dimensions			Permissible load N/pair	Mass $[\text{g}/\text{pair}]$
		$A \pm 0.3$	$B \pm 0.3$	n (pcs)		
80	80	50.0	—	2	20	94
100	100	70.0	—	2	30	118
150	160	60.0	120.0	3	80	179
200	223	85.0	170.0	3	140	241
300	345	135.0	270.0	3	145	364

Note) The Permissible Load and Mass each indicate when used as a pair of 2 units.

Model number coding

D20 +300L

Model number Overall rail length (mm)

[Permissible Load and Mounting Orientation]

For use other than with the mounting orientation shown in Fig.1, contact THK.

The permissible load of the Slide Rail indicates the load in the direction P_a that two rails can receive in the middle of the inner rail length at the maximum stroke.

The mounting orientation shown in Fig.2 is applicable to model FBL35B only.

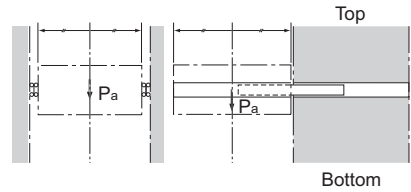

Fig.1

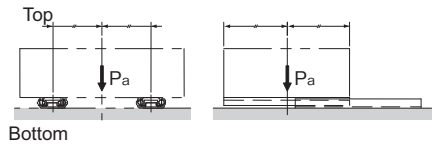

Fig.2 Applicable to model FBL35B only

The mounting orientation of Fig.3 is applicable to model FBL35F and model FBL56F.
 The mounting orientation of Fig.4 is applicable to model FBL48DR. To prevent a moment load from being applied, position the center of gravity of the door on the ball and the cage center lines, and ensure that the section A of the hanger is structured to allow free rotation.
 The mounting orientation of Fig.5 is applicable to model E36RS.
 Unlike other slide rails, model FBL48DR and model E36RS are used with a single rail. Therefore, set the load application position so that it is on the ball and the cage center lines.

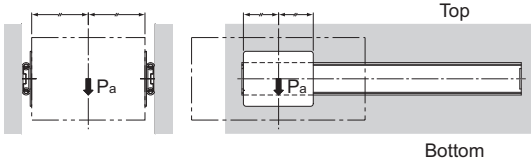

Fig.3 Applicable to model FBL35F, model FBL56F

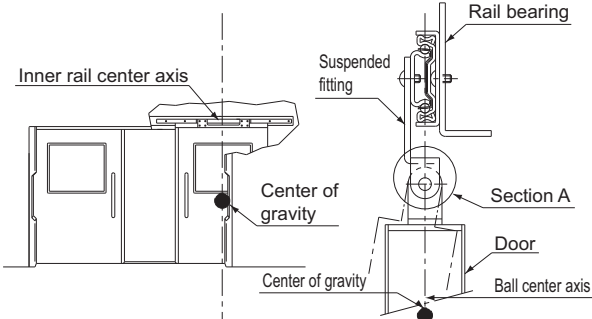

Fig.4 Applicable to model FBL48DR

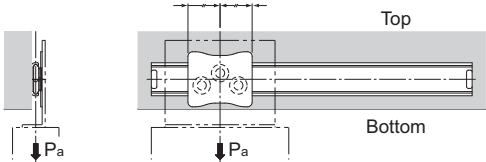

Fig.5 Applicable to model E36RS

[Surface Treatment]

The surface of the Slide Rail is electro-galvanized (treated with trivalent chromate) as standard. The aluminum slide rail of models E and D is white alumite-treated as standard. The slider of model E36RS is electro-galvanized (trivalent chromate treatment) and the rail is white alumite-treated as standard. For other surface treatments, contact THK.

Model Number Coding

Model number configurations differ depending on the model features. Refer to the corresponding sample model number configuration.

[Single slide/Double slide]

- Models FBL 27S, FBL 27S-P14, FBL 35S, FBL 35S-P13, FBL 35S-P14, FBL 35M, FBL 35J, FBL 35B, FBL 35T, FBL 27D, FBL 35E, FBL 35E-P14, FBL 35G-P13, FBL 35G-P14, FBL 35D, FBL 35W, FBL 51H, FBL 51H-P13, FBL 51H-P14, FBL 35K, FBL 56H, FBL 56H-P13 and FBL 56H-P14

FBL27S +300L

Model No. Overall rail length (in mm)

[Linear Type Slides]

- Models FBL35F and FBL56F

FBL35F +356L #5

Model No. Overall rail length (in mm) Model number of mounting plate

[Heavy Load Linear Type Slide]

- Model FBL48DR

FBL48DR +1810/696L

Model No. Outer rail length (in mm) Inner rail length (in mm)

[Linear Slide Wheel-type]

- Model E36RS

E36RS +550L

Model number Overall rail length (mm)

[Aluminum Alloy Slide Rail]

- Models E15, E20 and D20

E15 +100L

Model No. Overall rail length (in mm)

[Handling]

- (1) Tilting a Slide Rail may cause it to fall by its own weight.
- (2) Do not disassemble the parts. This will result in loss of functionality.
- (3) Take care not to drop or strike the Slide Rail. Doing so may cause injury or damage. Giving an impact to it could also cause damage to its function even if the product looks intact.
- (4) When handling the product, wear protective gloves, safety shoes, etc., as necessary to ensure safety.

[Precautions on Use]

- (1) When mounting the Slide Rail, use care to always keep both rails in parallel.
- (2) Prevent foreign material, such as cutting chips or coolant, from entering the product. Failure to do so may cause damage.
- (3) If the product is used in an environment where cutting chips, coolant, corrosive solvents, water, etc., may enter the product, use bellows, covers, etc., to prevent them from entering the product.
- (4) If foreign material such as cutting chips adheres to the product, replenish the lubricant after cleaning the product.
- (5) Avoid using the product at other than normal temperature, or using it in harsh conditions such as intensive reciprocations that generate frictional heat and environments with water or dust.
- (6) The durability of the Slide Rail varies depending on factors such as the drawing dimension, travel distance, mounting conditions and environment in addition to operating frequency. Take these factors into account when making a selection.
- (7) Note that the cage may be offset as affected by vertical mount, machine vibration, etc. To correct the cage position, perform the full-close and full-open operations. During these operations, the balls slip to make the stroke motion less smooth. If offset of the cage is inevitable, we recommend using Slide Packs, LM Guides, etc., which are infinite linear motion systems.
- (8) If you replace an old slider or outer rail of your E36RS with a new one, the clearance and sliding resistance may substantially increase.
- (9) Do not use the supplied stopper as a mechanical stopper. This may damage the stopper due to impact.
- (10) Do not use undue force when fitting parts (pin, key, etc.) to the product. This may generate pressure marks on the raceway, leading to loss of functionality.
- (11) Insufficient rigidity or accuracy of mounting members causes the bearing load to concentrate on one point and the bearing performance will drop significantly. Accordingly, give sufficient consideration to the rigidity/accuracy of the housing and base and strength of the fixing bolts.

[Lubrication]

- (1) High-quality lithium soap-based grease is applied to the Slide Rail. Do not mix different lubricants. Mixing greases using the same type of thickening agent may still cause adverse interaction between the two greases if they use different additives, etc.
- (2) The consistency of grease changes according to the temperature. Take note that the slide resistance of the Slide Rail also changes as the consistency of grease changes.
- (3) After lubrication, the slide resistance of the Slide Rail may increase due to the agitation resistance of grease. Be sure to let the grease spread fully before use.

- (4) Excess grease may scatter immediately after lubrication, so wipe off scattered grease as necessary.
- (5) The properties of grease deteriorate and its lubrication performance drops over time, so grease must be checked and added properly according to the use frequency of the machine.
- (6) The greasing interval varies depending on the use condition and service environment. Set the final lubrication interval/amount based on the actual machine.

[Storage]

When storing the Slide Rail, enclose it in a package designated by THK and store it in a room in a horizontal orientation while avoiding high temperature, low temperature and high humidity.

After the product has been in storage for an extended period of time, lubricant inside may have deteriorated, so add new lubricant before use.

[Disposal]

Dispose of the product properly as industrial waste.



Slide Rail

THK General Catalog

B Support Book

Features and Types	A13-2
Features of the Slide Rail	A13-2
• Structure and Features	A13-2
Types of the Slide Rail	A13-3
• Types and Features	A13-3
Classification Table for Slide Rails.....	A13-12
Mounting Procedure	A13-14
Mounting the Slide Rail.....	A13-14
Model No.	A13-17
• Model Number Coding	A13-17
Precautions on Use	A13-19

A Product Descriptions (Separate)

Features and Types	A13-2
Features of the Slide Rail	A13-2
• Structure and Features	A13-2
Types of the Slide Rail	A13-3
• Types and Features	A13-3
Classification Table for Slide Rails.....	A13-12

Dimensional Drawing, Dimensional Table

Model FBL 27S	A13-14
Model FBL 27S-P14	A13-15
Model FBL 35S	A13-16
Model FBL 35S-P13	A13-17
Model FBL 35S-P14	A13-18
Model FBL 35M	A13-19
Model FBL 35J	A13-20
Model FBL 35B	A13-21
Model FBL 35T	A13-22
Model FBL 27D	A13-23
Model FBL 35E	A13-24
Model FBL 35E-P14	A13-25
Model FBL 35G-P13	A13-26
Model FBL 35G-P14	A13-27
Model FBL 35D	A13-28
Model FBL 35W	A13-29
Model FBL 51H	A13-30
Model FBL 51H-P13	A13-31
Model FBL 51H-P14	A13-32
Model FBL 35K	A13-33
Model FBL 56H	A13-34
Model FBL 56H-P13	A13-35
Model FBL 56H-P14	A13-36
Model FBL 35F	A13-37
Model FBL 56F	A13-38
Model FBL 48DR	A13-39
Model E36RS	A13-40
Model E15	A13-41
Model E20	A13-42
Model D20	A13-43

Point of Design	A13-44
------------------------------	--------

Model No.	A13-46
• Model Number Coding	A13-46

Precautions on Use	A13-48
---------------------------------	--------

Features of the Slide Rail

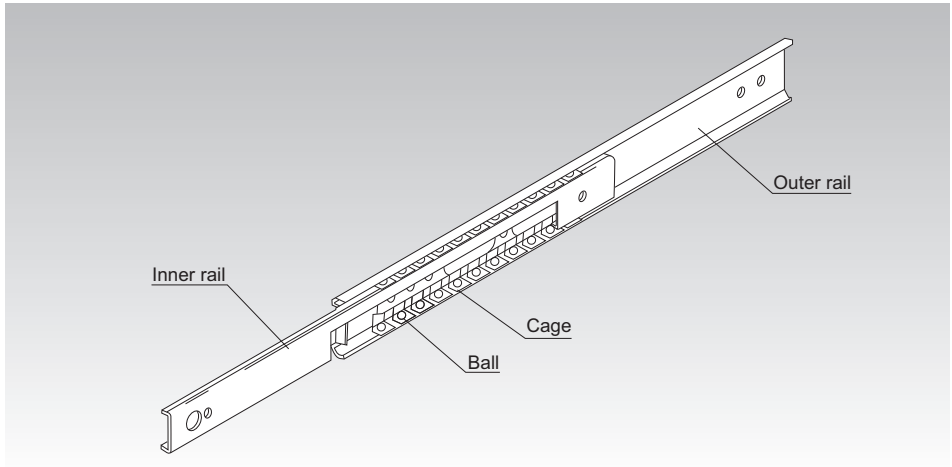

Fig.1 Structure of Slide Rail Model FBL

Structure and Features

Slide Rail model FBL is a thin, compact, lightweight and ultra-low price slide unit for finite motion. It has two rows of balls placed between an inner rail (made of a steel sheet roll-formed with precision) and an outer rail. The balls are evenly spaced by a cage press-molded with precision, thus eliminating friction between balls and achieving a smooth slide mechanism.

Since model FBL achieves smooth straight motion with easy installation, it can be used in a wide range of applications such as photocopiers, measuring instruments, telecommunication equipment, medical equipment, automatic vending machines and various types of office equipment.

[Unit Type That Allows Easy Installation]

Since the clearance and the motion of the slide unit are optimally adjusted, simply mounting the unit onto the base or the table using screws will achieve a slide mechanism with virtually no running noise.

[Thin and Compact]

Since the sectional shape is thin designed, this slide pack only requires a small side space for installation. In addition, a desired number of slide pack units can be installed in parallel according to the load conditions.

[Maintenance-free Operation]

Since the Slide Rail model FBL is treated with zinc plating, and models E and D are treated with white alumite treatment, they are highly corrosion resistant. In addition, the slide unit contains lithium soap-based grease, which is highly stable against oxidation.

Types of the Slide Rail

Types and Features

[Single Slides for Light Load]

Model FBL 27S

The most compact slide rail from THK.

Specification Table⇒ **A** 13-14

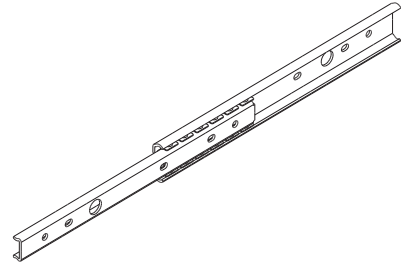

Model FBL 27S

Model FBL 27S-P14

An inner rail pulling type of model FBL 27S. Releasing the automatic free disconnection spring attached on the inner rail allows the slide rail to be pulled out. When stored, the spring is automatically released unidirectionally under a certain pressure.

Specification Table⇒ **A** 13-15

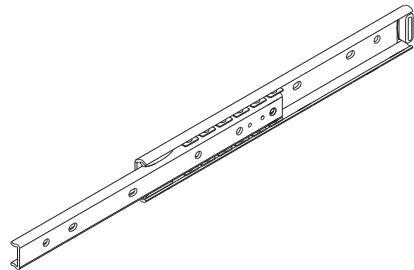

Model FBL 27S-P14

Model FBL 35S

A single slide type of Slide Rail with the most fundamental shape.

Specification Table⇒ **A** 13-16

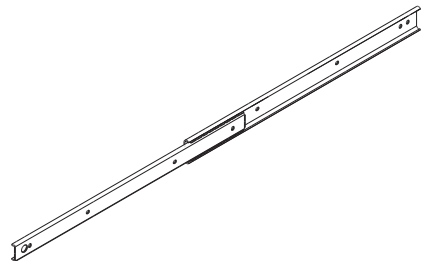

Model FBL 35S

Model FBL 35S-P13

Specification Table⇒ **A13-17**

An inner rail pulling type of model FBL 35S. Releasing the disconnection spring attached on the inner rail allows the slide rail to be pulled out. When folded, the locked state with the disconnect spring is manually released.

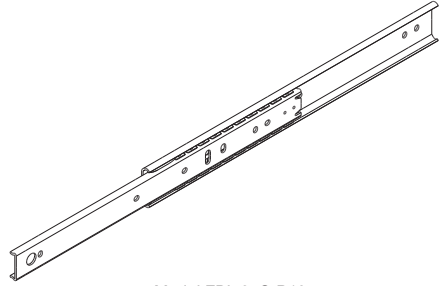

Model FBL 35S-P13

Model FBL 35S-P14

Specification Table⇒ **A13-18**

An inner rail pulling type of model FBL 35S. Releasing the automatic free disconnection spring attached on the inner rail allows the slide rail to be pulled out. When stored, the spring is automatically released unidirectionally under a certain pressure.

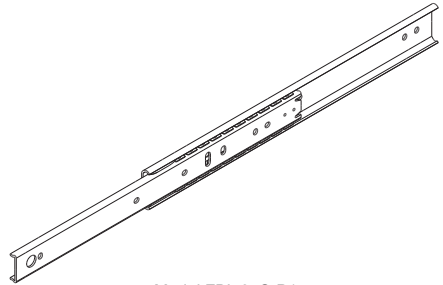

Model FBL 35S-P14

Model FBL 35M

An inner rail pulling type of model FBL 35S. It stops by frictional resistance when the slide rail is fully opened, and is pulled out when being pulled further with force.

(brake-stop type)

Specification Table⇒ **A** 13-19

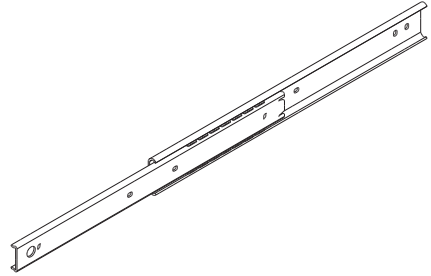

Model FBL 35M

Model FBL 35J

Based on model FBL 35M, this model has a lead ball that serves as a guide when the inner rail is inserted.

Specification Table⇒ **A** 13-20

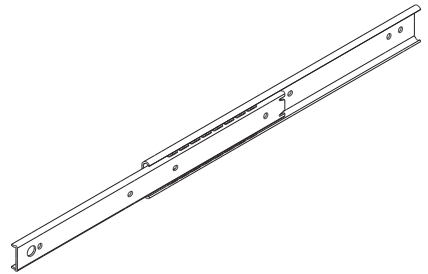

Model FBL 35J

Model FBL 35B

A brake-stop type of model FBL 35M. It can be mounted on the bottom face of a moving object when used.

Specification Table⇒ **A** 13-21

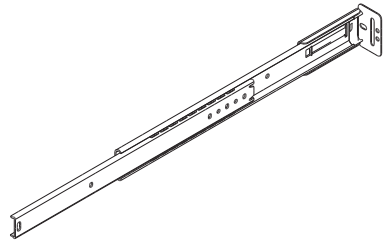

Model FBL 35B

[Single Slides for Medium Load]

Model FBL 35T

Specification Table⇒ **A13-22**

A single slide combining two units of model FBL 35S. It is optimal for locations under a large working load.

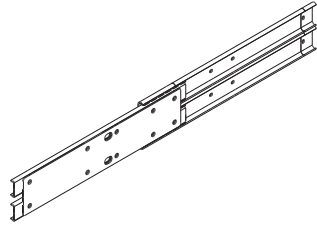

Model FBL 35T

[Double Slides for Light Load]

Model FBL 27D

Specification Table⇒ **A13-23**

A double-slide type that combines two units of model FBL 27S back-to-back. It is widely used in various types of OA equipment.

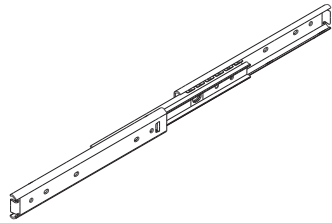

Model FBL 27D

Model FBL 35E

Specification Table⇒ **A13-24**

This is a 2-level slide-unit type suitable for restricted spaces, featuring a stroke length that can exceed the total rail length.

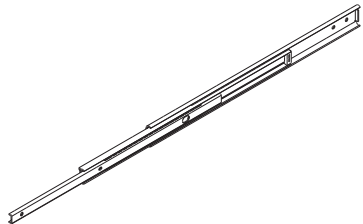

Model FBL 35E

Model FBL 35E-P14

Specification Table⇒ **A13-25**

A three-rail, double-slide type that allows a long stroke in a small space. Releasing the automatic free disconnection spring attached on the inner rail allows the inner rail to be pulled out. When closed, the locked state is automatically released under pressure in the closing direction.

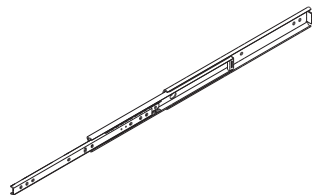

Model FBL 35E-P14

[Double Slides for Medium Load]

Model FBL 35G-P13

A double-slide type that combines two units of model FBL 35S front-to-front. Releasing the automatic free disconnection spring attached on the inner rail allows the inner rail to be pulled out. When folded, the locked state with the disconnect spring is manually released. It is also equipped with a pull-lock mechanism that functions when the slide rail is fully opened.

Specification Table⇒ **A** 13-26

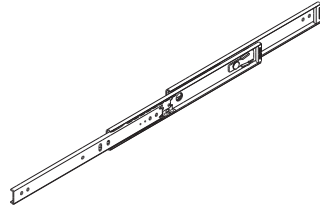

Model FBL 35G-P13

Model FBL 35G-P14

A double-slide type that combines two units of model FBL 35S front-to-front. Releasing the automatic free disconnection spring attached on the inner rail allows the inner rail to be pulled out. When folded, the lock state with the disconnect spring can automatically be released under a certain pressure in the folding direction. It is also equipped with a pull-lock mechanism that functions when the slide rail is fully opened.

Specification Table⇒ **A** 13-27

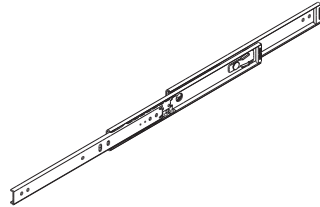

Model FBL 35G-P14

Model FBL 35D

A double-slide type that combines two units of model FBL 35S back-to-back. It is extensively used regardless of the industry.

Specification Table⇒ **A** 13-28

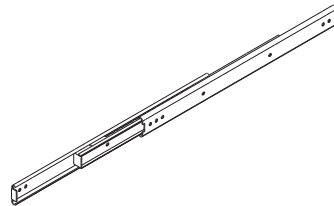

Model FBL 35D

Model FBL 35W

A double-slide type based on model FBL 35S that achieves a thickness of one single-slide unit.

Specification Table⇒ **A** 13-29

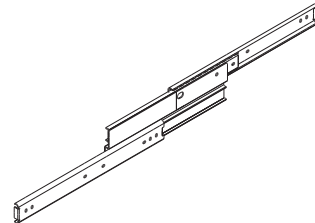

Model FBL 35W

Model FBL 51H

Specification Table⇒ **A13-30**

A three-rail, double-slide type that allows a long stroke. With the smallest thickness, this model can be used in a space-saving location even under a large load.

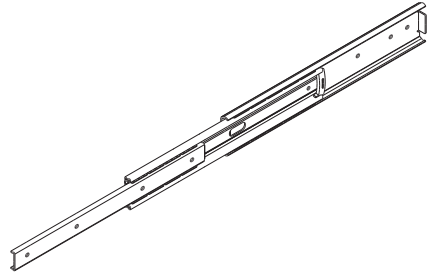

Model FBL 51H

Model FBL 51H-P13

Specification Table⇒ **A13-31**

A three-rail, double-slide type that allows a long stroke. With the smallest thickness, this model can be used in a space-saving location even under a large load. Releasing the automatic free disconnection spring attached on the inner rail allows the inner rail to be pulled out. When folded, the locked state with the disconnect spring is manually released. It is also equipped with a lock mechanism that functions when the slide rail is fully opened.

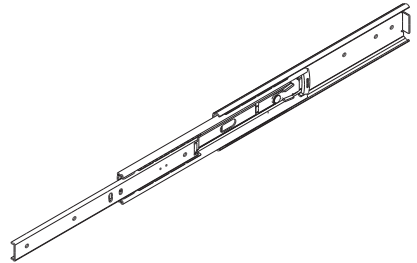

Model FBL 51H-P13

Model FBL 51H-P14

Specification Table⇒ **A13-32**

A three-rail, double-slide type that allows a long stroke. With the smallest thickness, this model can be used in a space-saving location even under a large load. Releasing the automatic free disconnection spring attached on the inner rail allows the inner rail to be pulled out. When closed, the locked state is automatically released under pressure in the closing direction.

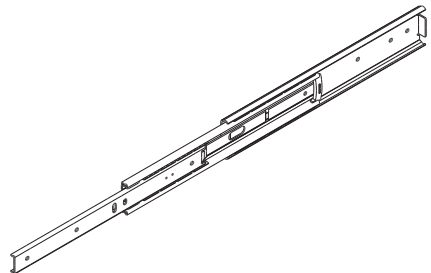

Model FBL 51H-P14

[Double Slides for Heavy Load]

Model FBL 35K

A double-slide type combining 4 units of model FBL 35S. It achieves the largest permissible load among all types and is optimal for opening/closing heavy objects.

Specification Table⇒ **A 13-33**

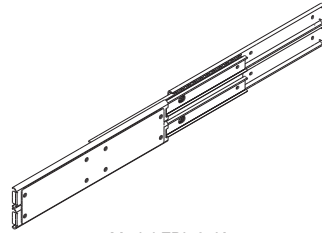

Model FBL 35K

Model FBL 56H

A double-slide type with the largest permissible load among the three rails. It is used extensively in various types of OA furniture.

Specification Table⇒ **A 13-34**

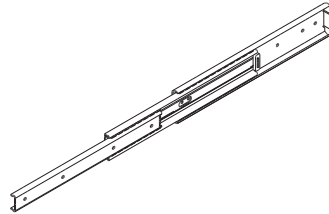

Model FBL 56H

Model FBL 56H-P13

A double-slide type with the largest permissible load among the three rails. Releasing the automatic free disconnection spring attached on the inner rail allows the inner rail to be pulled out. When folded, the locked state with the disconnect spring is manually released. It is also equipped with a lock mechanism that functions when the slide rail is fully opened.

Specification Table⇒ **A 13-35**

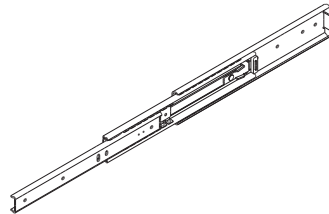

Model FBL 56H-P13

Model FBL 56H-P14

A double-slide type with the largest permissible load among the three rails. Releasing the automatic free disconnection spring attached on the inner rail allows the inner rail to be pulled out. When closed, the locked state is automatically released under pressure in the closing direction.

Specification Table⇒ **A 13-36**

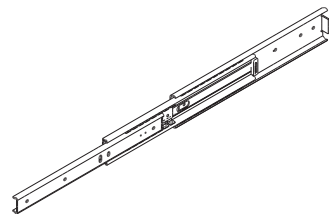

Model FBL 56H-P14

[Linear Type Slides]

Light Load Type Model FBL 35F

Specification Table⇒ **A13-37**

Using a flange type that can easily be mounted, this slide-type model is capable of performing straight, finite motion.

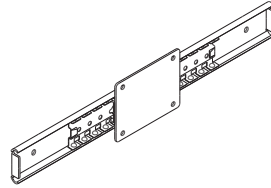

Light Load Type Model FBL 35F

Medium Load Type Model FBL 56F

Specification Table⇒ **A13-38**

Using a flange type that can easily be mounted, this slide-type model is capable of performing straight, finite motion. It is optimal for locations under a large working load.

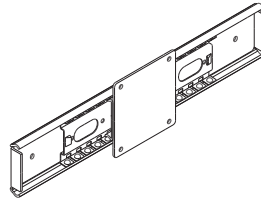

Medium Load Type Model FBL 56F

Heavy Load Type Model FBL 48DR

Specification Table⇒ **A13-39**

A heavy-load, low-friction slide rail developed for sliding heavy doors.



Heavy Load Type Model FBL 48DR

[Wheel-type Linear Slide]

Model E36RS

Specification Table⇒ **A13-40**

A linear slide that combines a lightweight outer rail made of precision-extruded aluminum alloy with a highly wear-resistant resin bearing.

Since no grease adheres to the rail surface, it can be used for a drawer without soiling the stored articles.

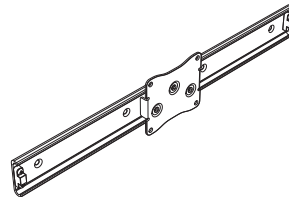

Model E36RS

[Aluminum Alloy Slide Rail]

Light Load Type Model E15

The lightest and most compact single slide in the aluminum alloy series. It is especially suitable for locations with magnetism, locations requiring antirust measures and locations where much importance is given to appearance.

Specification Table⇒ **A** 13-41

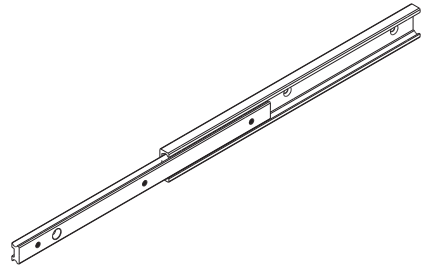

Light Load Type Model E15

Light Load Type Model E20

A single-slide with the most fundamental shape in the aluminum alloy series. It is especially suitable for locations with magnetism, locations requiring antirust measures and locations where much importance is given to appearance.

Specification Table⇒ **A** 13-42

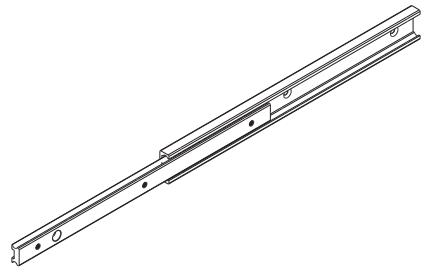

Light Load Type Model E20

Light Load Type Model D20

The lightest and most compact double slides in the aluminum alloy series. It is especially suitable for locations with magnetism, locations requiring antirust measures and locations where much importance is given to appearance.

Specification Table⇒ **A** 13-43

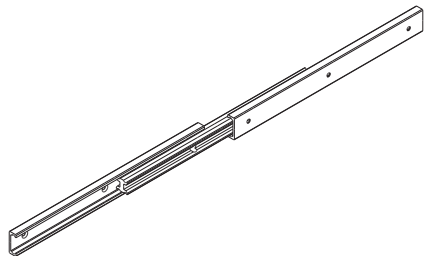





Light Load Type Model D20

Classification Table for Slide Rails

Slide Rail

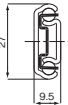
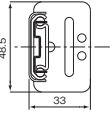
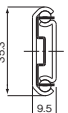
Single Slide Double Slide

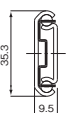
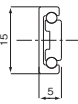
For Light Load

<p>Model FBL27S</p> <p>Model FBL27S-P14</p> 	<p>Model FBL35B</p> 
<p>Model FBL35S</p> <p>Model FBL35S-P13</p> <p>Model FBL35S-P14</p> 	<p>Model FBL35J</p> 
<p>Model FBL35M</p> 	<p>Model E15 (Made of Aluminum)</p> 
	<p>Model E20 (Made of Aluminum)</p> 

For Medium Load

Model FBL35T

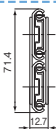

For Light Load

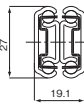
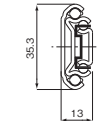
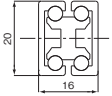
<p>Model FBL27D</p> 	<p>Model FBL35E</p> <p>Model FBL35E-P14</p> 
<p>Model D20 (Made of Aluminum)</p> 	

For Heavy Load

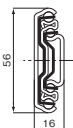
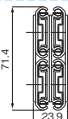
<p>Model FBL56H</p> <p>Model FBL56H-P13</p> <p>Model FBL56H-P14</p> 
<p>Model FBL35K</p> 

Linear Type Slide

For Medium Load

Model FBL35G-P13

Model FBL51H

Model FBL35G-P14

Model FBL51H-P13

Model FBL51H-P14

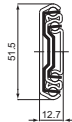
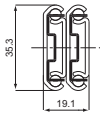

Model FBL35D

Model FBL35W

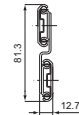
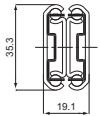

For Light Load

Model FBL35F

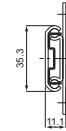

For Medium Load

Model FBL56F



For Heavy Load

Model FBL48DR

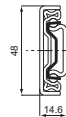

Wheel Type

Model E36RS (Aluminum Outer Rail)



Slide Rail

Mounting the Slide Rail

[Mounting Screws of the Slide Rail]

The slide rail is designed to be mounted using M4 screws. Since the mounting space is small as shown in Fig.1, we recommend using button head or binding head bolts.

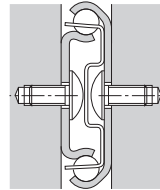

Fig.1

Note that the mounting screw for the slide rail of the models indicated in the following table is different.

Model number	button-head bolt	binding-head bolt	countersunk screw
Models FBL27S/27S-P14/27D	M3	M3 , M4	—
Model E15	—	—	M2.6
Models E20/D20	—	—	M3
Model FBL35E	M3	M3	—
Model E36RS	—	—	M4

Note) For button head bolts, binding head bolts, and countersunk screws, see the appendix of JIS B 1111.

[Attaching the Slide Rail]

At full extension of the slide, mount the outer rail at the overlap of rails. Followed by full retraction of the slide and mount the opposite end using the access hole.

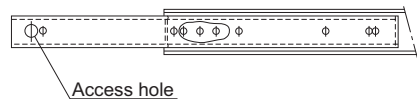

Fig.2

* For the following model numbers, mount outer rail after removing inner rail, as shown in Fig.3.

Models: FBL27S-P14, FBL35S-P13, FBL35S-P14, FBL35M, FBL35J, FBL35B, FBL35E-P14, FBL35G-P13, FBL35G-P14, FBL51H-P13, FBL51H-P14, FBL56H-P13, FBL56H-P14

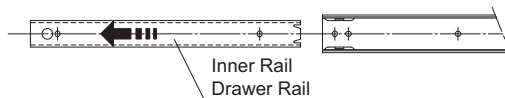

Fig.3

Mounting Procedure

Mounting the Slide Rail

In addition, when mounting the outer rail or cabinet rail of models FBL35G-P13, FBL35G-P14, FBL51H-P13 and FBL56H-P13, which have locking mechanisms, release the lock by pressing the lock plate in the direction indicated in Fig.4 and adjust the position of the access hole.

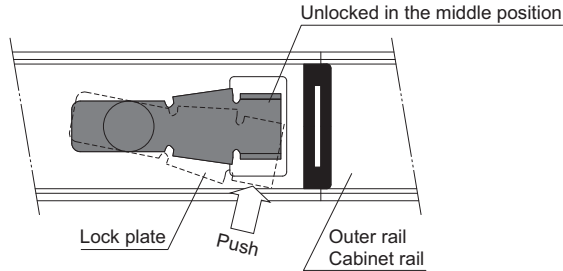

Fig.4

* For the following models, mount the inner rail by sliding it in the contracting direction as show in Fig.5. When doing so, do not remove the inner rail from the outer rail. If the inner rail is pulled out, it may be difficult to reinsert.

Models: FBL27S, FBL35S, FBL35T

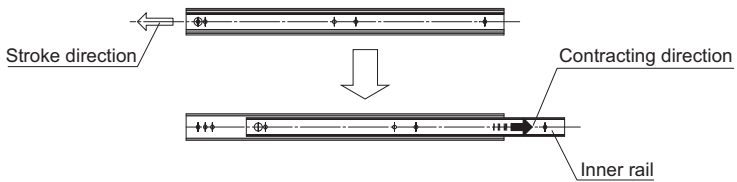

Fig.5

[Permissible Load and Mounting Orientation]

For use other than with the mounting orientation shown in Fig.6, contact THK.

The permissible load of the Slide Rail indicates the load in the direction P_a that two rails can receive in the middle of the inner rail length at the maximum stroke.

The mounting orientation shown in Fig.7 is applicable to "model FBL35B" only.

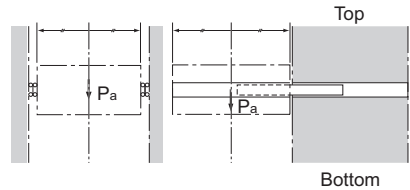

Fig.6

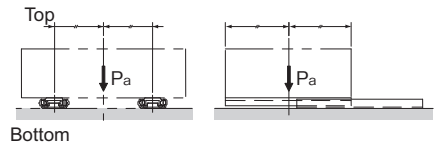

Fig.7 Applicable to "model FBL35B" only

The mounting orientation of Fig.8 is applicable to model FBL35F and model FBL56F.
 The mounting orientation of Fig.9 is applicable to model FBL48DR. To prevent a moment load from being applied, position the center of gravity of the door on the ball and the cage center lines, and ensure that the section A of the hanger is structured to allow free rotation.
 The mounting orientation of Fig.10 is applicable to model E36RS.
 Unlike other slide rails, model FBL48DR and model E36RS are used with a single rail. Therefore, set the load application position so that it is on the ball and the cage center lines.

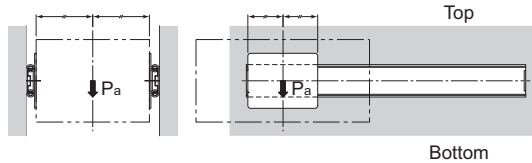

Fig.8 Applicable to model FBL35F, model FBL56F

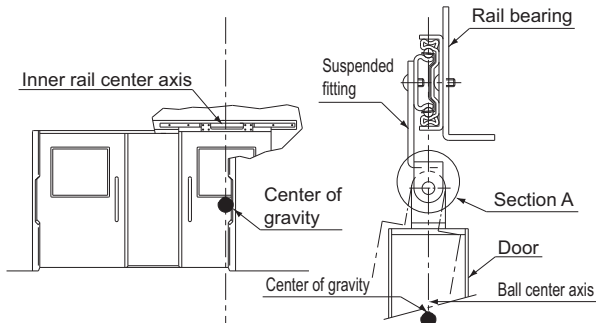

Fig.9 Applicable to model FBL48DR

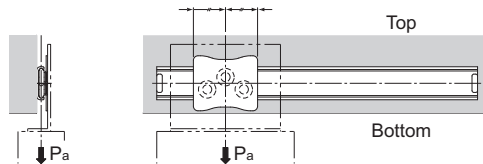

Fig.10 Applicable to model E36RS

[Surface Treatment]

The surface of the Slide Rail is electro-galvanized (treated with trivalent chromate) as standard.
 The aluminum slide rail of models E and D is white alumite-treated as standard. The slider of model E36RS is electro-galvanized (trivalent chromate treatment) and the rail is white alumite-treated as standard. For other surface treatments, contact THK.

Model Number Coding

Model number configurations differ depending on the model features. Refer to the corresponding sample model number configuration.

[Single slide/Double slide]

- Models FBL 27S, FBL 27S-P14, FBL 35S, FBL 35S-P13, FBL 35S-P14, FBL 35M, FBL 35J, FBL 35B, FBL 35T, FBL 27D, FBL 35E, FBL 35E-P14, FBL 35G-P13, FBL 35G-P14, FBL 35D, FBL 35W, FBL 51H, FBL 51H-P13, FBL 51H-P14, FBL 35K, FBL 56H, FBL 56H-P13 and FBL 56H-P14

FBL27S +300L

Model No. Overall rail length (in mm)

[Linear Type Slides]

- Models FBL35F and FBL56F

FBL35F +356L #5

Model No. Overall rail length (in mm) Model number of mounting plate

[Heavy Load Linear Type Slide]

- Model FBL48DR

FBL48DR +1810/696L

Model No. Outer rail length (in mm) Inner rail length (in mm)

[Linear Slide Wheel-type]

- Model E36RS

E36RS +550L

Model number Overall rail length (mm)

[Aluminum Alloy Slide Rail]

- Models E15, E20 and D20
-

E15 **+100L**

Model No. Overall rail length (in mm)

[Handling]

- (1) Tilting a Slide Rail may cause it to fall by its own weight.
- (2) Do not disassemble the parts. This will result in loss of functionality.
- (3) Take care not to drop or strike the Slide Rail. Doing so may cause injury or damage. Giving an impact to it could also cause damage to its function even if the product looks intact.
- (4) When handling the product, wear protective gloves, safety shoes, etc., as necessary to ensure safety.

[Precautions on Use]

- (1) When mounting the Slide Rail, use care to always keep both rails in parallel.
- (2) Prevent foreign material, such as cutting chips or coolant, from entering the product. Failure to do so may cause damage.
- (3) If the product is used in an environment where cutting chips, coolant, corrosive solvents, water, etc., may enter the product, use bellows, covers, etc., to prevent them from entering the product.
- (4) If foreign material such as cutting chips adheres to the product, replenish the lubricant after cleaning the product.
- (5) Avoid using the product at other than normal temperature, or using it in harsh conditions such as intensive reciprocations that generate frictional heat and environments with water or dust.
- (6) The durability of the Slide Rail varies depending on factors such as the drawing dimension, travel distance, mounting conditions and environment in addition to operating frequency. Take these factors into account when making a selection.
- (7) Note that the cage may be offset as affected by vertical mount, machine vibration, etc. To correct the cage position, perform the full-close and full-open operations. During these operations, the balls slip to make the stroke motion less smooth. If offset of the cage is inevitable, we recommend using Slide Packs, LM Guides, etc., which are infinite linear motion systems.
- (8) If you replace an old slider or outer rail of your E36RS with a new one, the clearance and sliding resistance may substantially increase.
- (9) Do not use the supplied stopper as a mechanical stopper. This may damage the stopper due to impact.
- (10) Do not use undue force when fitting parts (pin, key, etc.) to the product. This may generate pressure marks on the raceway, leading to loss of functionality.
- (11) Insufficient rigidity or accuracy of mounting members causes the bearing load to concentrate on one point and the bearing performance will drop significantly. Accordingly, give sufficient consideration to the rigidity/accuracy of the housing and base and strength of the fixing bolts.

[Lubrication]

- (1) High-quality lithium soap-based grease is applied to the Slide Rail. Do not mix different lubricants. Mixing greases using the same type of thickening agent may still cause adverse interaction between the two greases if they use different additives, etc.
- (2) The consistency of grease changes according to the temperature. Take note that the slide resistance of the Slide Rail also changes as the consistency of grease changes.
- (3) After lubrication, the slide resistance of the Slide Rail may increase due to the agitation resistance of grease. Be sure to let the grease spread fully before use.

- (4) Excess grease may scatter immediately after lubrication, so wipe off scattered grease as necessary.
- (5) The properties of grease deteriorate and its lubrication performance drops over time, so grease must be checked and added properly according to the use frequency of the machine.
- (6) The greasing interval varies depending on the use condition and service environment. Set the final lubrication interval/amount based on the actual machine.

[Storage]

When storing the Slide Rail, enclose it in a package designated by THK and store it in a room in a horizontal orientation while avoiding high temperature, low temperature and high humidity.

After the product has been in storage for an extended period of time, lubricant inside may have deteriorated, so add new lubricant before use.

[Disposal]

Dispose of the product properly as industrial waste.